

Use and Maintenance Manual for AIR Stoves

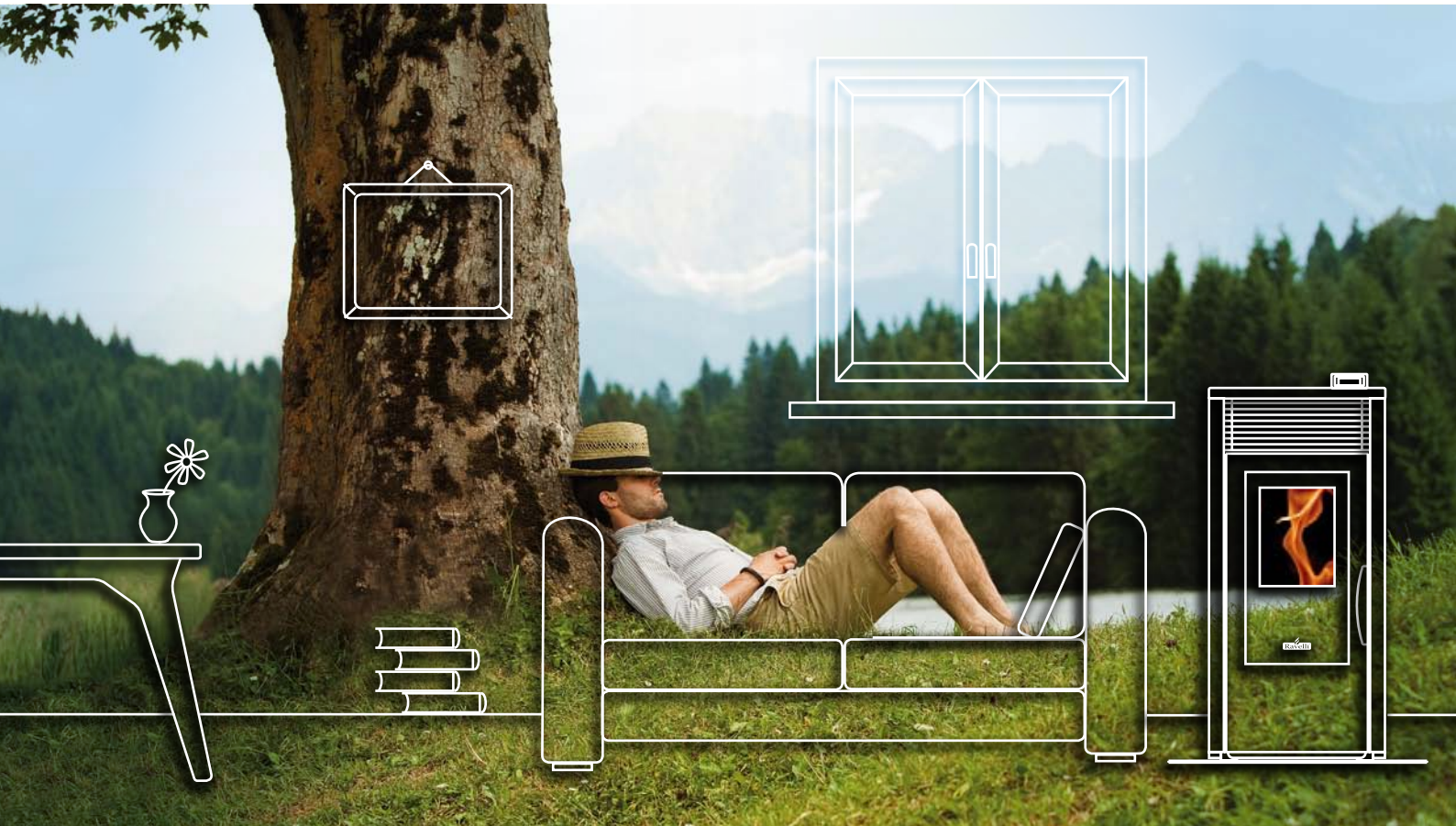

SAVE THESE INSTRUCTIONS

Please read this entire manual before installation and use of this pellet fuel-burning room heater. Failure to follow these instructions could result in property damage, bodily injury or even death. Contact local building or fire officials about restrictions and installation inspection requirements in your area. Contact local authorities to see if a permit must be obtained before installation.

ASTME 1509-04 • UL 1482-00 • ULCS 627-00 • ULC-ORDC 1482-90 • Oregon Administration Rules 814-23-909 • Mobile Home Approved



MANUFACTURER'S CERTIFICATE

Issued pursuant to law no. 449 of 27/12/1997 and Circular of the Ministry of Finance no. 57/E of 24/02/1998 (Tax subsidies on renovation of buildings) extended by Law no. 488 of 23/12/1999 and 2001 Finance Act:

Ravelli srl hereby certifies that the following products

***LISA PLUS, FRANCESCA 2011, MONICA, ILARIA, SERENA, SOFIA,
SILVIA, LAURA, VERONICA***

with an interior made up of: a steel hearth and fire pot, a vermiculite combustion chamber, a vitroceramic door resistant to high temperatures, adjustable primary air and electronic control board, are included in the types of work for energy saving (in accordance with Law 10/91 and Presidential Decree no. 412 of 26/08/1993) which can benefit from the tax allowances connected with energy saving in buildings (in accordance with article 1, letter g) of Ministerial Decree 15/02/1992 (Official Journal of 09/05/1992 no. 107).

The above product is included in the heat generators that use products of plant origin as their source of energy and which in normal operating conditions present a yield, measured using the direct method, of not less than 70%.

Palazzolo sull'Oglio

Ravelli srl

Table of contents

1. Thank you.....	Page	4
2. Safety information.....	Page	5
3. General.....	Page	5
3.1 Responsibility.....	Page	5
3.2 Spare parts.....	Page	5
3.3 The majolica finishes.....	Page	6
3.4 What the wood pellets are.....	Page	6
3.5 The components of the stove.....	Page	6
4. Safety devices.....	Page	7
5. Technical features.....	Page	7
6. Positioning, assembly and installation.....	Page	14
6.1 Environment of use.....	Page	14
6.2 Mobile Home Requirements.....	Page	14
6.3 Installation Examples.....	Page	15
6.4 Operating faults due to flue draught problems or critical weather conditions.....	Page	16
7. Description of the controls.....	Page	17
7.1 Description of the menus.....	Page	17
7.1.2 Setting the clock (clock setting menu).....	Page	17
7.1.3 Setting the language (language menu).....	Page	17
7.1.4 Stove status menu.....	Page	20
7.1.5 Working hours menu.....	Page	20
7.1.6 See settings menu.....	Page	20
7.1.7 Chronothermostat setting menu.....	Page	20
8. Description of functions.....	Page	21
8.1 Symbols.....	Page	21
9. Description of functions.....	Page	21
9.1 Modification of operating power.....	Page	21
9.2 Modulation.....	Page	21
9.3 Comfort Clima.....	Page	21
9.4 Modifications of the room temperature setting.....	Page	22
9.5 Setting pellet-air mixture.....	Page	22
9.6 Automatic loading of auger.....	Page	23
9.7 Switching the stove ON and OFF.....	Page	23
9.8 The remote control.....	Page	24
9.9 Synthetic table of phases.....	Page	24
9.10 Description of alarms.....	Page	25
10. Electric wiring diagrams.....	Page	27
10.1 Electric wiring diagram air stove.....	Page	27
10.2 Electric wiring diagram Elena airplus.....	Page	28
11. Maintenance.....	Page	29
11.1 Cleaning the surfaces.....	Page	29
11.2 Cleaning the fire pot.....	Page	29
11.3 Cleaning Firex 600.....	Page	29
11.4 Disposal of ash.....	Page	30
11.5 Cleaning the Vent Pipe.....	Page	30
12. Guarantee.....	Page	30
12.1 Certificate of guarantee.....	Page	30
12.2 Conditions of guarantee.....	Page	30
12.3 Information and problems.....	Page	30

Introduction

Important:

Please read this manual carefully. It describes all the phases necessary for perfect functioning of the stove.

Warning:

The regulations on installation and operation in this manual may differ from the regulations in force locally. In this case, the indications of the competent local authorities must always be followed. The drawings shown in this manual are indicative and not to scale.

Information:

The packaging that we have used offers good protection against any damage due to transport. Always check the stove immediately after delivery: in the event of any damage, please inform your Ravelli dealer immediately.

Description of use and maintenance manual

With this use and maintenance manual, Ravelli wishes to provide the user with all the information on safety in using the stove, in order to avoid damage to persons or things or parts of the stove. Please read this manual carefully before use and any work on the product.

WARNINGS

Ravelli stoves are manufactured taking care even on the individual components in order to protect both the user and the installer from any accidents.

The authorized personnel, after any work on the product, should therefore always pay special attention to the electrical connections.

Installation must be performed by authorized personnel, who must give the purchaser a declaration of conformity of the appliance, and who will assume all responsibility for the final installation and consequent good functioning of the product installed. It is also necessary to take into consideration all the laws and national, regional, provincial and local regulations present in the country in which the appliance has been installed. In the event of failure to respect these precautions, Ravelli S.R.L. declines all responsibility.

This instruction manual is an integral part of the product: please make sure that it is always with the stove, including in the case of transfer to another owner or user, or transfer to another place. In the case of its damage or loss, please request another copy from the Technical Department.

This stove must be used for the purpose for which it has been specifically manufactured. Do not use the appliance as an incinerator or in any way other than that for which it was designed. All contractual and tort responsibility of the manufacturer is excluded for damage caused to persons, animals or things, due to errors of installation, maintenance regulation or improper use. No other fuel except the pellets must be used. Do not use flammable liquids, (gasoline, gasoline type lantern fuel, kerosene, charcoal, lighter fluid, or similar liquids to start or freshen up a fire in these heaters.

After having removed the packaging, please make sure that the contents are complete and intact.

All the electrical components that make up the stove must be replaced with original spare parts exclusively from an authorized technical assistance center. **Maintenance of the stove must be performed at least once a year, planning it in time with the technical assistance center.** Do not make any unauthorized modification to the appliance.

For safety reasons, please remember that:

- the stove must not be used by children or disabled people without assistance;
- do not touch the stove when barefoot or when any parts of the body are wet;
- the safety devices or adjustment devices must not be modified without the authorization or instructions of Ravelli.
- During installation, the user must be informed that:
 1. in the event of leakage of water, the water supply must be turned off and the technical service advised immediately.
 2. The operating pressure of the appliance must be checked periodically. If the stove is not used for a long time, then the technical assistance should perform at least the following operations:
 - Close the water taps of both the heating appliance and the water supply.
 - Empty the heating appliance and the water supply if there is a risk of freezing.

The stove, especially the external surfaces, reaches very high temperatures when it is in operation; take care when moving it to avoid burns.

The stove has been designed to function in any climatic condition; in the event of particularly adverse conditions (wind, freezing), safety systems could intervene which switch off the stove.

If this occurs, contact the technical assistance and, in any case, do not disable the safety systems.

1.Thank you

Dear Customer,

We would like to thank you and congratulate you on the excellent choice you have made.

With the Ravelli stove, you will see that quality and economy can go hand in hand, offering excellent performances with limited consumption and being totally practical. Please find below some suggestions, which we would like to give you, to obtain the most from your stove and to fully enjoy all the advantages that it can give you.

Through this, we want to be close to our customers to offer the maximum technical support to all those who use our technology.

Ravelli srl thanks you for your confidence
and wishes you happy times in the company
of your pellet stove.

2. Safety information

The stove must be installed and tested by specialized personnel instructed by the parent company. Please read this 'Use and maintenance manual' before installing and putting the stove into operation!

If you require further information, please contact your Ravelli dealer.

IMPORTANT

- The place of installation of the stove must comply with local, national and state regulations.
- The stove must be fuelled only with quality pellets with a diameter of 1/4 inch as described in the specific chapter.

The stove cannot operate with traditional wood

The stove must not be used as an incinerator. FIRE HAZARD!!!

- **Installation, the electrical connections, checking the functioning and maintenance must be performed by qualified and authorized personnel.**
- **Improper installation or poor maintenance (not compliant with what is shown in the following manual) may cause damage to persons and things. In this condition, Ravelli is relieved of all civil or criminal responsibility.**
- Before connecting the stove electrically, the connection of the exhaust tubes must be completed (specifically for pellet stoves, not made from aluminium) with the flue.
- The protection grille inside the pellet tank must never be removed.
- There must be sufficient circulation of air in the room where the stove is installed.
- Never open the door of the stove while it is functioning. **FIRE HAZARD!!!**
- **The oven must not be used with the door open or with the glass broken. FIRE HAZARD!!!**
- When the stove is operating, the surfaces, the glass, the handle and the pipes become overheated: during functioning, these parts must only be touched with the adequate protection.
- **Do not light the stove without having first performed the daily inspection as described in the MAINTENANCE chapter of this manual.**
- **Do not place any washing on the stove to dry. Keep clothes horses and similar at a suitable distance from the stove. FIRE HAZARD!!!**

- Scrupulously follow the maintenance program.
- Do not switch off the stove by disconnecting the electricity main supply.
- Do not clean the stove until the structure and the ashes have cooled down completely.
- Carry out all operations in maximum safety and tranquillity.

3. General

The Stove must only operate in rooms. As it is controlled by an electronic board, combustion is completely automatic and controlled and the control unit regulates the ignition phase, 5 levels of power and the switching off phase, guaranteeing safe functioning.

The chamber used for combustion allows most of the ashes produced by the combustion of the pellets to fall into the collection drawer. However, always check the frame every day, as not all pellets have high standards of quality and could leave residue that is difficult to remove.

The glass has a special air circulation for self-cleaning. However, a slight greyish film cannot be avoided after a few hours of functioning.

As already mentioned earlier, pellets with a diameter of 1/4" inch must be used with the stove. However, it may also operate with pellets having a different diameter, in this case please contact your Ravelli dealer.

Do not over fire stoves. If stove does not light on first try, stop, clean out fire pot and restart stove.

3.1 Responsibility

Ravelli declines all responsibility, both civil and criminal, with the delivery of this manual, for any accidents deriving from partial or total failure to observe the instructions it contains,

Ravelli declines all responsibility deriving from the improper use of the stove, from its incorrect use by the user, by unauthorized modifications and/or repairs or from the use of spare parts which are not original.

Ravelli declines all direct civil or criminal responsibility due to:

- poor maintenance
- failure to observe the instructions in the manual
- use not compliant with the safety instructions
- installation that is not compliant with the regulations in force in the country.
- installation by personnel who are not qualified or authorized
- modifications and repairs that are not authorized by the manufacturer
- use of spare parts that are not original
- exceptional events

3.2 Spare parts

Use original spare parts only. Do not wait for the components to be worn before replacing them. Replace a worn component before it is completely broken to prevent any accidents caused by the sudden breakage of components, perform the periodic maintenance checks as described in the dedicated chapter.

3.3. Majolica finishes

The cast majolica stoves with a special hand finish may cause surface imperfections such as shadowing and details that make every majolica one of its kind. As it is a delicate material, please handle with care while cleaning and avoid blows as sudden breakage may occur. Please also take care when loading the hopper (Ed.'s note; tank containing the pellets) with the sack of pellets: do not place it on the stove!

3.4. What are the wood pellets

The wood pellets are made from sawdust and wood shavings produced in joiners' shops. The material used cannot contain any foreign substance such as glue, varnish or synthetic substances.

Subjecting it to high pressure, the wood is pressed through a plate with holes and due to the high pressure the sawdust is heated activating the natural binders of the wood. Thus, the pellets keep their shape even without the addition of bonding substances. The density of the wood pellet varies according to the type of wood and can be 1.5 – 2 times greater than that of natural wood.

The diameter of the cylindrical rods is 6-10 mm and their length can vary between 10 and 50 mm.

Their weight is equal to about 650 kg/m. Due to the low content of water (5-10%) they have a high energy content.

The standards DIN 51731 define the quality of the pellets:

Length: 3/8 - 2 inches approx.
 Diameter: 1/4 Inch approx.
 Moisture Content: 5 - 10% approx.

Do not put the bag of pellets on the ceramic parts during the loading operations.



Fig.1



Fig.2

The pellets must be transported and stored in a dry place. They swell on contact with damp, and cannot be used. They must always be protected from the damp both during transport and in storage.

Ravelli recommends using a pellet with a diameter of 1/4" inch for the stove.

Otherwise it will be necessary to ask the assistance center for the appropriate regulations.

3.5. The components of the stove

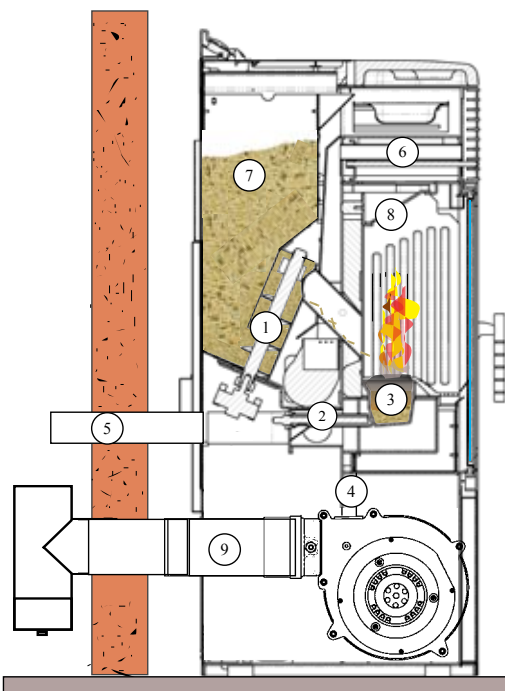

1. pellet loading auger
2. resistance unit for ignition
3. combustion fire pot
4. tube for passage of smoke
5. air intake tube
6. stainless steel exchanger
7. pellet hopper
8. flame trap
9. smoke exhaust tube

This drawing shows the internal parts of a pellet stove. By filling the tank (7), the pellets are loaded into the fire pot (3) through the loading auger (1). Ignition is by means of the resistance (2), which overheats the air from the special entrance (5) which on contact with the pellets will allow the development of the flame. At this point the exhaust smoke is deviated towards the stainless steel exchanger (6) and through the smoke extraction tube (4) it is released into the flue, through the connection with the smoke exhaust pipe. (9).

4. Safety devices

The oven is fitted with sophisticated safety systems so that, in the case of breakage of one of the individual parts or defects in the flue, no damage will be caused to the stove and the room in which it is installed. In any case, when a problem arises, the pellets stop falling immediately and the switch off phase is activated.

The corresponding alarm will be shown on the display. The details can be seen in the chapter on the alarms.

5. TECHNICAL FEATURES

All Ravelli products are manufactured according to the following directives:

- 89/106 EEC construction materials
- 73/23 EEC electrical safety
- 2006/42/EEC machines
- 2004/108 EEC electromagnetic compatibility

And according to the following standards:

- EN 14785
- EN 60335-1 EN 50165
- EN 292 EN 294 EN 349
- EN 55014.1 EN 61000-3-2 EN 61000-3-3
- EN 55014.2

	Unit of measurement	Lisa Plus	Francesca 2011	Monica
Height	Inch	35.5	37	37.75
Width	Inch	17.75	17.95	20.5
Depth	Inch	17.75	19.95	18
Weight	Lbs	187	210	286
Diameter of smoke exit tube	Inch	3.14	3.14	3.14
Min-max thermal power	BTU/h	8,500 - 25,500	8,500 - 25,500	8,500 - 29,000
Min-max. hourly consumption of pellets	Lbs/h	1.1 - 2.75	1.1 - 3.5	1.1 - 4
Supply	V - Hz	120 - 60	120 - 60	120 - 60
Hopper capacity	Lbs	33	33	33
Efficiency	%	84	84	84
Smoke temperature min - max	°F	135 - 168	153 - 185	153 - 195

The data shown above are indicative and not binding. Ravelli reserves the right to make any modifications for the purpose of improving the performances of the product.

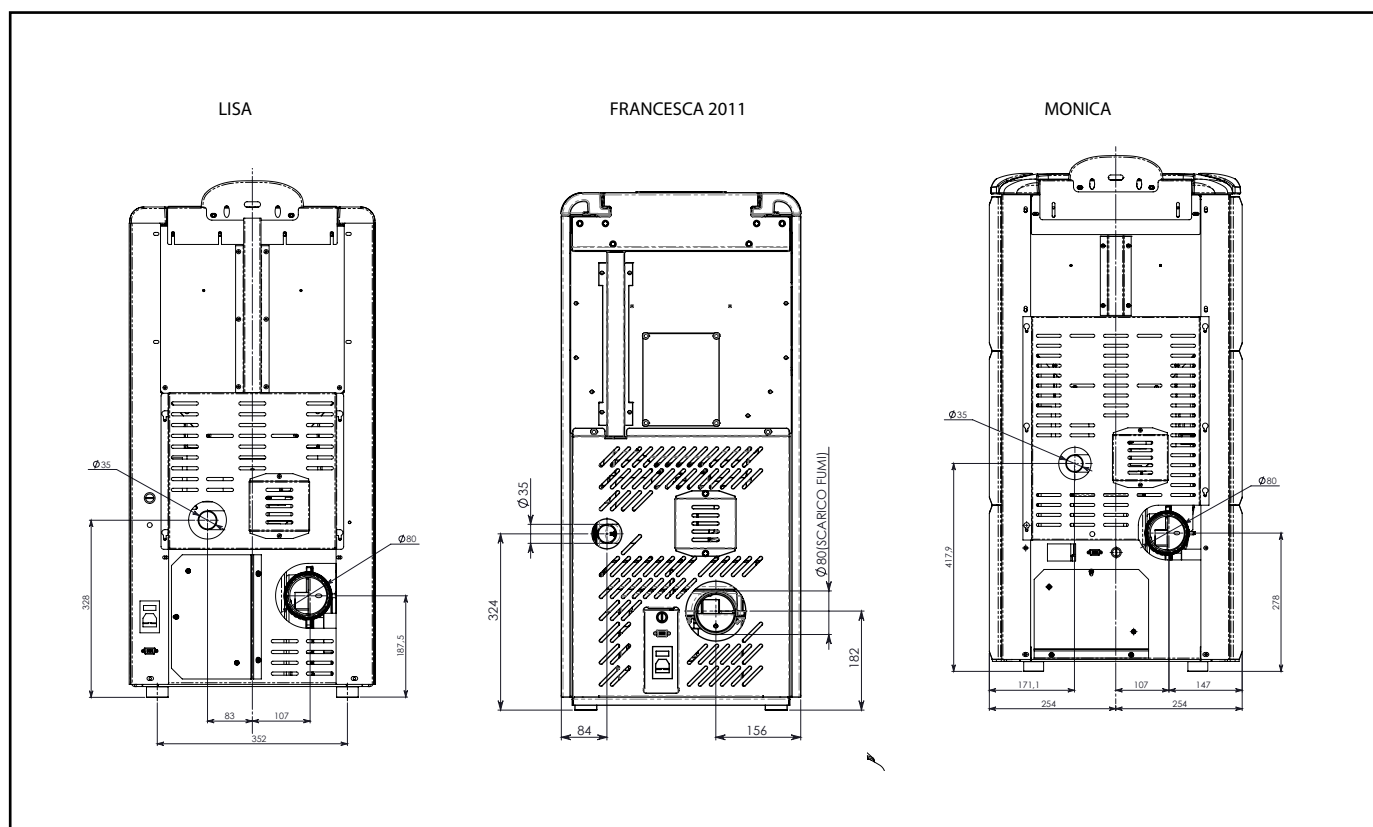

	Unit of measurement	Serena - Ilaria	Veronica - Laura
Height	Inch	42.5	41.75
Width	Inch	20.87	22.5
Depth	Inch	21.25	24
Weight	Lbs	264 - 242	374 - 341
Diameter of smoke exit tube	Inch	3.14	3.14
Min-max thermal power	BTU/h	8,500 - 34,000	8,500 - 37,500
Min-max. hourly consumption of pellets	Lbs/h	1.1 - 5.0	1.1 - 5.0
Supply	V - Hz	120 - 60	120 - 60
Hopper capacity	Lbs	44	66
Efficiency	%	84	92
Smoke temperature min - max	°F	217 - 408	145 - 255

The data shown above are indicative and not binding. Ravelli reserves the right to make any modifications for the purpose of improving the performances of the product.

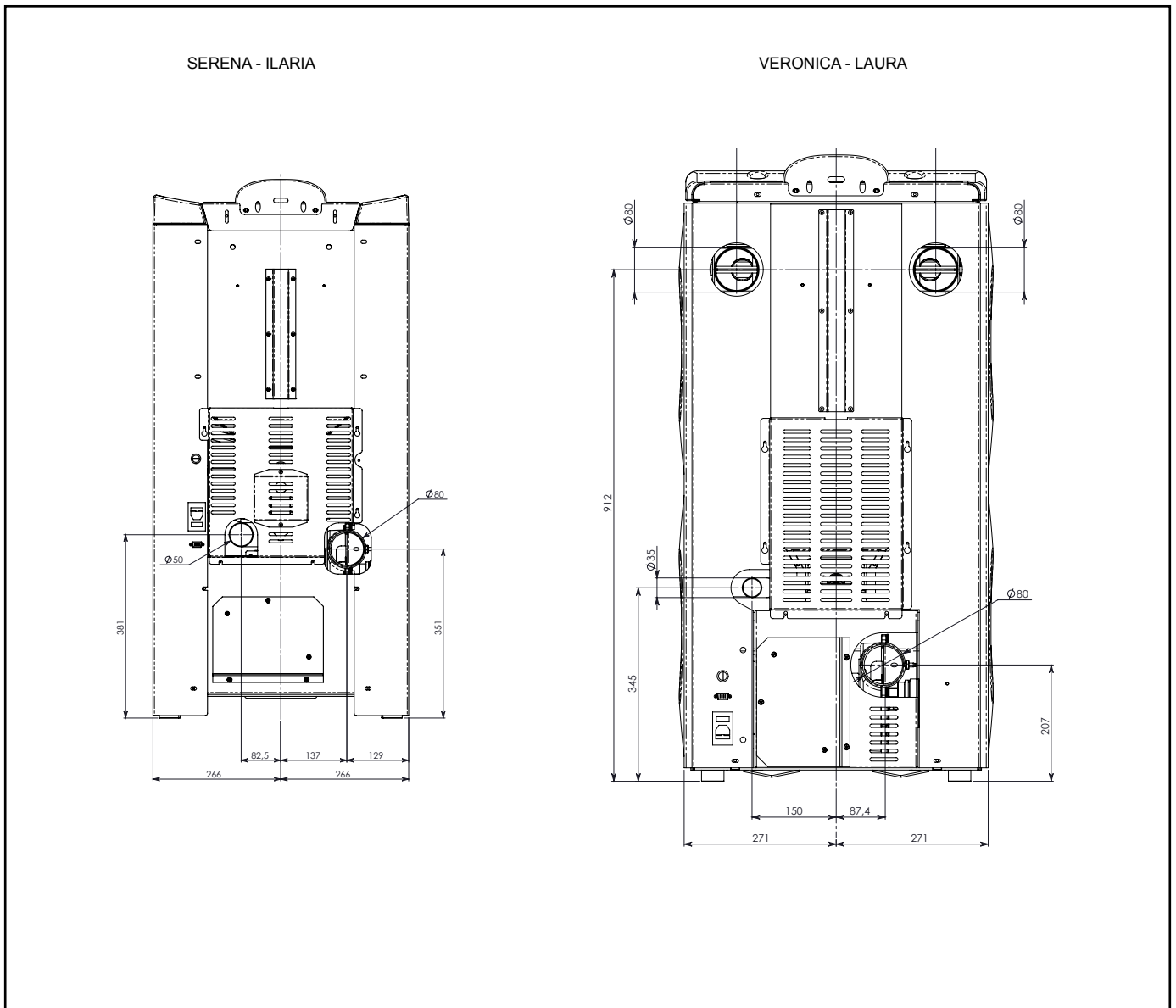

	Unit of measurement	Sofia	Silvia
Height	Inch	39.37	39.37
Width	Inch	24.75	24.80
Depth	Inch	23.62	23.62
Weight	Lbs	374	264
Diameter of smoke exit tube	Inch	3.14	3.14
Min-max thermal power	BTU/h	8,500 - 41,000	8,500 - 42,500
Min-max. hourly consumption of pellets	Lbs/h	1.1 - 5.7	1.1 - 5.5
Supply	V - Hz	120 - 60	120 - 60
Hopper capacity	Lbs	55	46
Efficiency	%	84	84
Smoke temperature min - max	°F	217 - 408	217 - 408

The data shown above are indicative and not binding. Ravelli reserves the right to make any modifications for the purpose of improving the performances of the product.

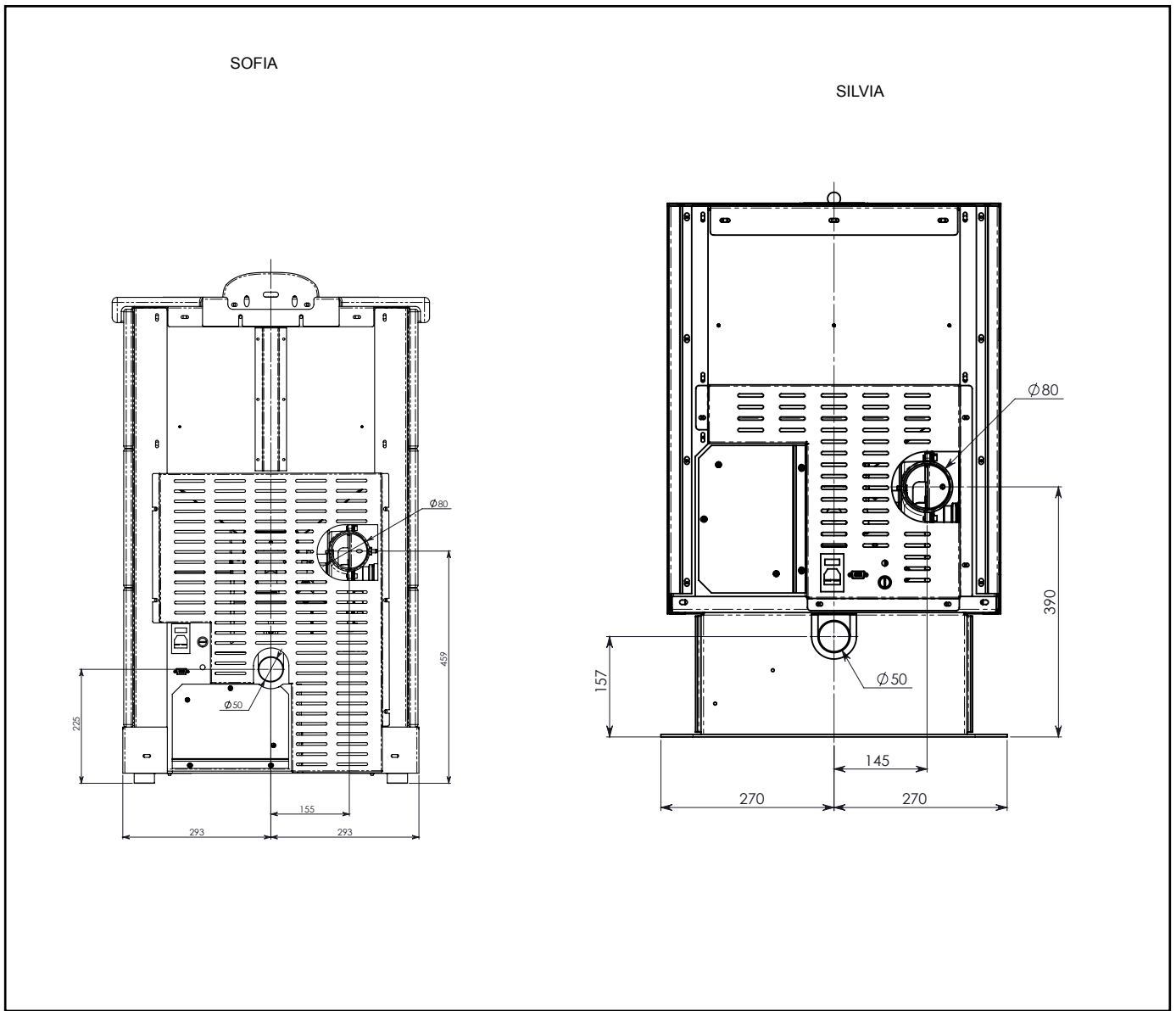

6. Positioning, assembly and installation

6.1 Environment of use

The positioning of the stove is decisive for successful even heating of the room. Before deciding where to place the stove, the following must be taken into account:

- The stove must be installed on a floor with a sufficient carrying capacity. If the existing building does not meet this requisite, appropriate measures must be taken (i.e. load distribution plate).
- The combustion air cannot be obtained from a garage or from an area without ventilation or exchange of air, but from a free or external space
- The stove must not be installed in a bedroom, bathroom or shower, or where there is already another heating appliance without an autonomous air flow (chimney, stove etc.)
- A minimum of 3" inches from the rear of the stove, 3" inches from the side of the stove and 16" inches from the top of the stove must be maintained from combustible materials.
- A non-combustable Hearth board 6" from front of unit and 6" from the sides must be installed before unit is placed on the floor.
- Installation is better in a large and central room in the house to ensure maximum circulation of the heat;
- Connection to the main supply is recommended using a grounded outlet (if the cable supplied is not long enough to reach the nearest outlet, use an extension cord with a surge protector);
- The stove must be placed in a position that receives the necessary level of air for appropriate combustion of the pellets (at least 131.23 f³/h must be available), in accordance with installation regulation and local legislations;
- All joints for connector pipe is required to be fastened with at least three screws.
- If vented horizontally joint should be siliconed with hi-temp. silicone and screwed so they are gas tight. (RTU 500 silicone)

The stove must be installed and assembled by qualified personnel.

The room must be:

- Prepared for the environmental functioning conditions
- Prepared with an adequate system of evacuation of smoke
- Have a 120V 60 Hz (EN73-23) electricity mains supply
- Do not connect this unit to a chimney flue serving another appliance
- Use only pellet vent 3" piping to exhaust. Do not install flue damper in the exhaust system of this unit.

6.2 Mobile Home Requirements

- Outside air is required
- The heater must be secured to the floor using lag bolts.
- The heater must be grounded to the chassis of the mobile home.
- Installation should be in accordance with the manufactured home.
- When outside air is required, system parts, such as vent sections, supports, spark arresters, rodent screens, etc. must be used.

WARNING: Do not install in bedroom

CAUTION: The structural integrity of the mobile home floor, ceiling, walls, roof must be maintained.

Refer to HUD Requirements, CFR 3280, Part 24

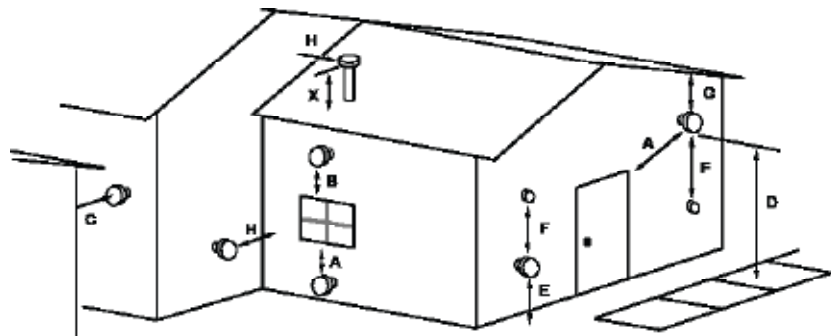

NOTE: Install vent at clearances specified by the vent manufactures.

NOTE: Measure clearances to the nearest edge of the exhaust hood.

NOTE: Vent may not terminate in covered walkway or breezeway.

NOTE: If venting horizontally, check your venting specifications for distance pipe should extrude from building.

- A Minimum 4' clearance below or beside any door or window that opens
Minimum 1' clearance below or beside any window that does not open.
- B Minimum 1' clearance above any door or window that opens
- C Minimum 2' clearance from any adjacent building
- D Minimum 7' clearance above any grade when adjacent to public walkways
- E Minimum 2' clearance above any grass, plants, or other combustible materials
- F Minimum 3' clearance from any forced air intake of any other appliance
- G Minimum 2' clearance below eaves or overhangs
- H Minimum 1' clearance horizontally from combustible wall
- X Must be a minimum of 2' above the roof

6.3 Installation Examples

Min Distances (in Inches)

- A: 3" Unprotected walls
- B: 6" Front & side of floor protection
- C: 3" Back of floor protection

Use these illustrations as a guide only. All units must be placed on a non-combustible floor protector with a minimum thickness of .018". All measurements are made at the top of the units. For additional information, please contact your local Ravelli dealer.

Back & Side Walls

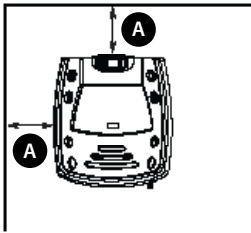

Corners

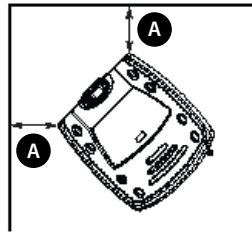

Floor Protection

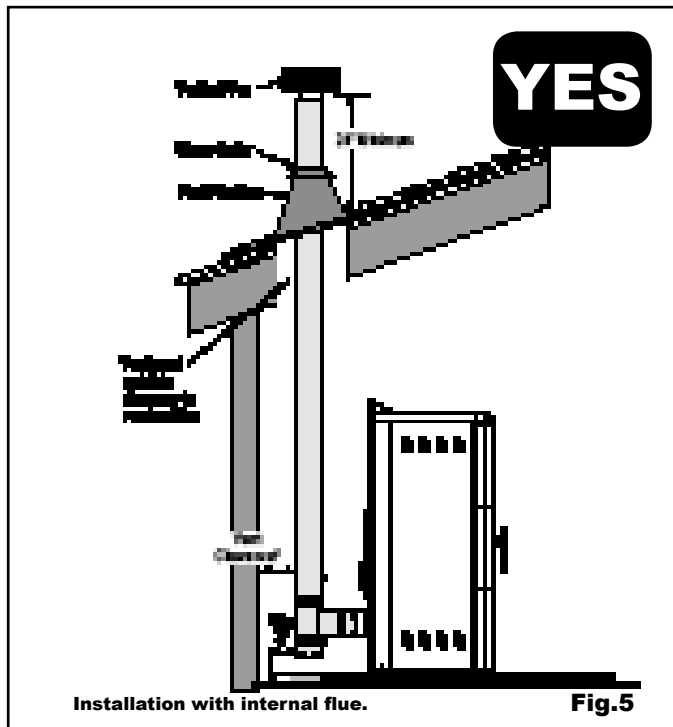
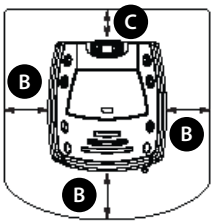

This type of installation (see Fig. 5), does not require an insulated flue, as all the whole pipe has been assembled inside the house. A union tee has been mounted in the lower part of the flue with a cleanout.

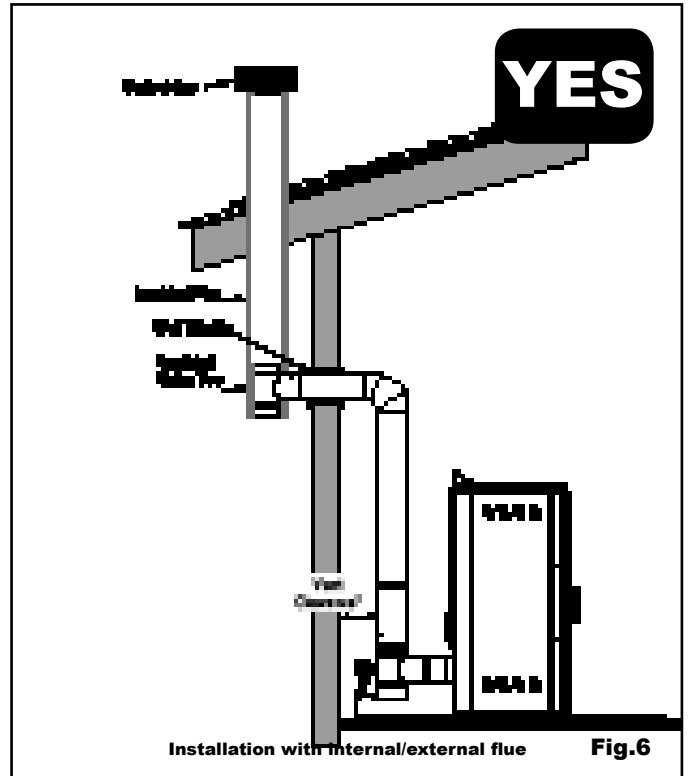

This type of installation (see fig. 6) does not require an insulated flue for the part inside the house, for the part outside an insulated tube must be used. In the lower part of the flue in the house, a union tee has been installed with a cleanout, but another one has also been installed outside, so that the part can be inspected. Two 90° bends should not be installed as the ash could quickly block the passage of smoke, causing problems for the draught of the stove.

Any pipe run longer than 3 feet must have a minimum 1/4 inch rise per 1 foot run.

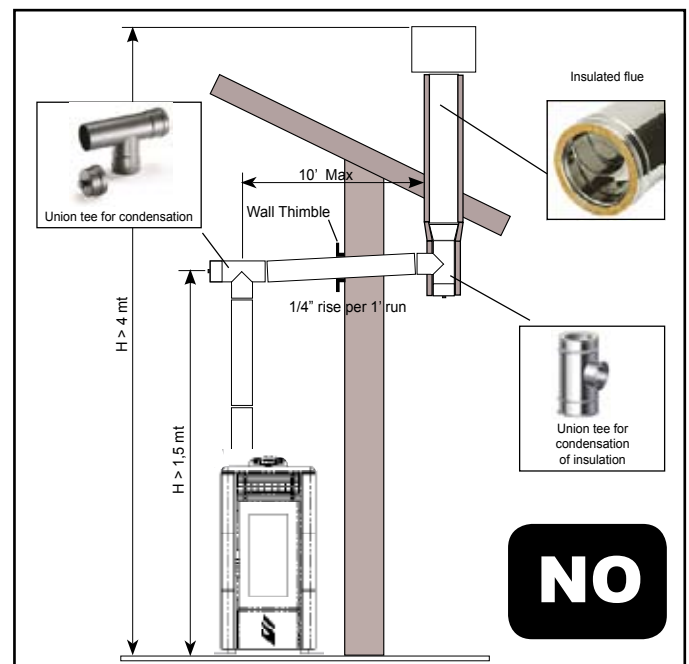

* For mobile home use, the outside air must be part of the application.

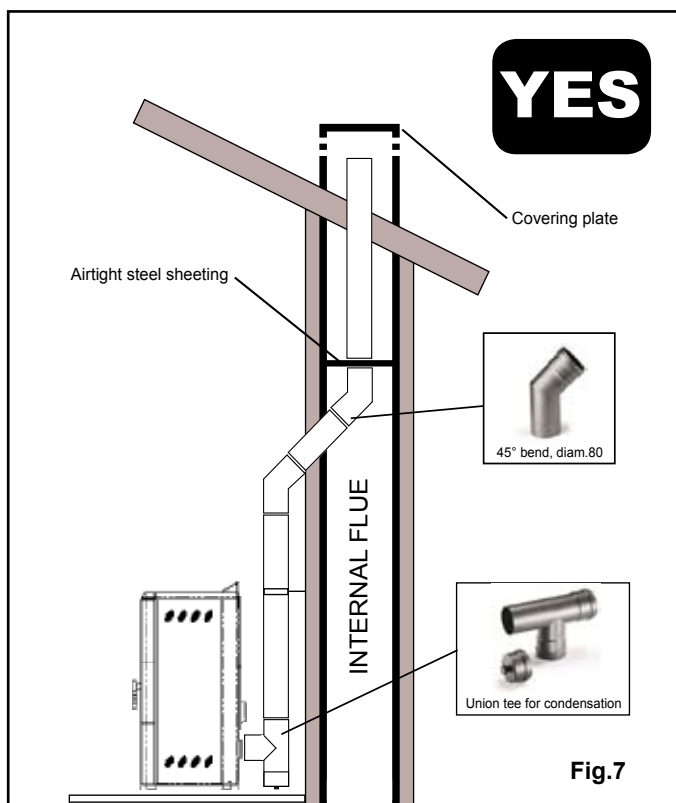

This type of installation (see Fig. 7) does not require an insulated flue as the exhaust pipe has been assembled partly inside the house and partly inside an existing flue. In the lower part of the flue a union tee has been installed with a cleanout cap.

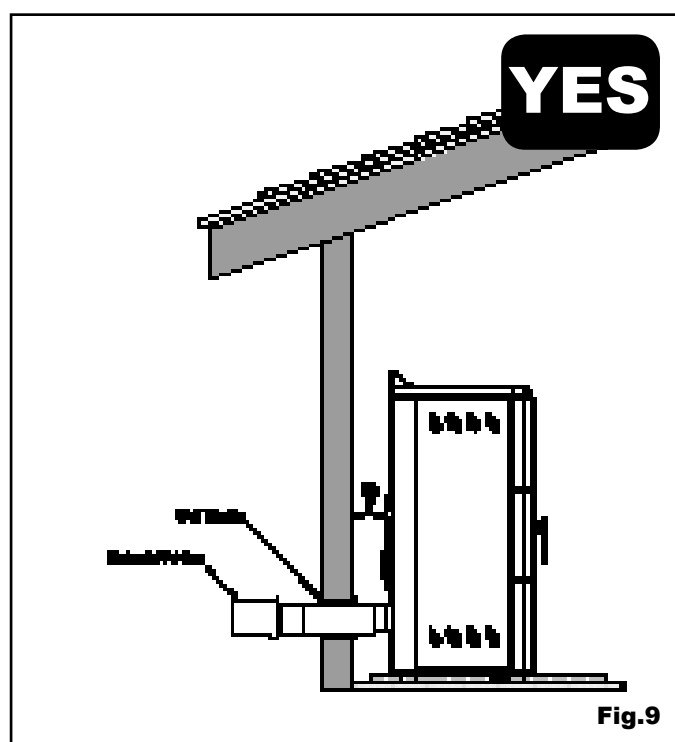
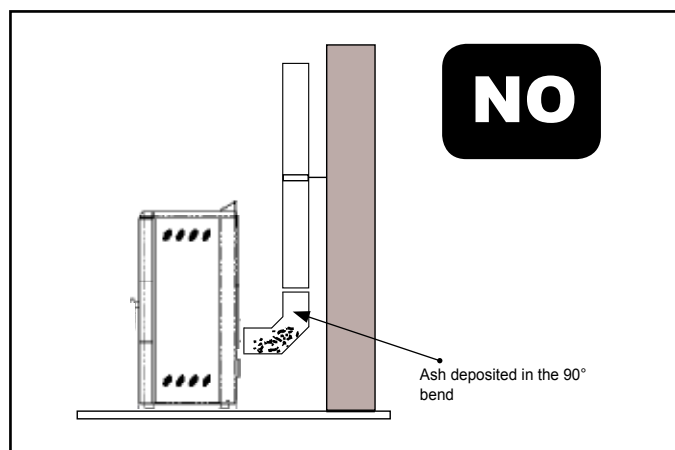

This type of installation (see Fig. 9) can be directly vented and terminated directly through the wall.

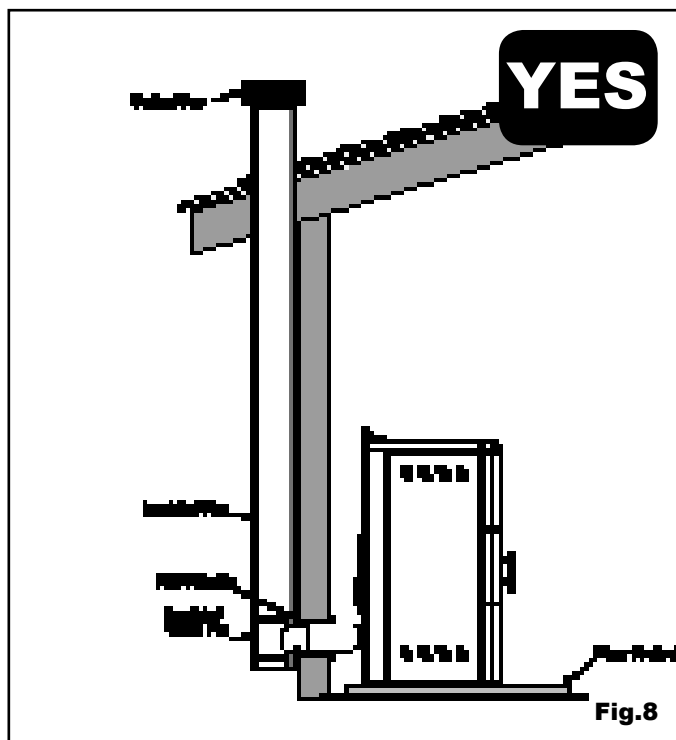

This type of installation (see Fig. 8) requires an insulated flue, as all the smoke pipe has been installed outside the house. In the lower part of the flue, a union tee has been mounted with an inspection cap.

6.4. Operating faults due to flue draught problems or critical weather conditions

Among all weather and geographical conditions that may have an impact on the operation of the draught flue (snow, rain, altitude above sl, fog, ...) wind is certainly the most important. In fact, in addition to the thermal depression caused by the temperature difference between the inside and the outside of the flue, there is another type of depression: dynamic depression caused by wind. Therefore, wind has an impact on the efficiency of the flue.

THE OPERATION OF THE PELLETS Stove IS THEREFORE STRONGLY DEPENDENT ON THE POSITION AND CONSTRUCTION OF THE FLUE. PRECARIOUS CONDITIONS CAN ONLY BE RESOLVED WITH AN APPROPRIATE SETTING OF THE Stove BY Ravelli APPROVED TECHNICAL PERSONNEL.

7 Description of the controls



- P1 : button to reduce working power
- P2 : button to increase working power
- P3 : on-off button
- P4 : button to reduce temperature
- P5 : button to increase temperature
- P6 : multifunction button
- P7 : multifunction button

Power switch is in the back of the stove

7.1 DESCRIPTION OF MENUS

The stove has various functions, available in its individual programming menus. Some of these menus are accessible by the user, others are protected by a password and accessible only by the Technical Assistance Center.

The menus are as follows:

- CLOCK SETTING Menu
- CHRONOTHERMOSTAT SET Menu
- LANGUAGE Menu
- SEE SETTINGS Menu
- Stove STATUS Menu
- WORKING HOURS Menu
- DATA BASE Menu (protected by a password)
- ZERO SET HOURS Menu (protected by a password)
- FACTORY SETTING Menu (protected by a password)
- SELECT RECEPIES Menu (protected by a password)

7.1.2. SETTING THE CLOCK (CLOCK SET Menu, STATUS Stove ON)

To set the clock, proceed as follows:

1. Keep the P4 button pressed for 2 seconds, CLOCK SET MENU will appear and confirm with the button P6.
2. DAY CLOCK will appear: with buttons P4 and P5 set the current day according to the table shown below and confirm with button P6.

Display	Meaning
Day 1	Monday
Day 2	Tuesday
Day 3	Wednesday
Day 4	Thursday
Day 5	Friday
Day 6	Saturday
Day 7	Sunday
OFF	Disactivated

3. TIME CLOCK will appear on the display and the current time will be shown: using buttons P4 and P5 adjust the times and confirm with button P6.
4. MINUTES CLOCK will appear on the display; set the minutes with buttons P4 and P5 and confirm with button P6.
5. Confirm with button P6 to return automatically to MENU' 01 CLOCK SETTING

7.1.3. SETTING THE LANGUAGE (LANGUAGE MENU, STATUS Stove ON)

To set the language, proceed as follows:

1. Keep button P4 pressed for 2 seconds, CLOCK SETTING MENU will appear.
2. Press button P4 twice; the display will show LANGUAGE MENU.
3. Access with button P6: the display will show the language selection.
4. With buttons P4 and P5, select the language desired, confirm with button P6.
5. Confirm with button P6 to return automatically to MENU' 03 SELECT LANGUAGE MENU.

The availability of languages may vary depending on the type of version of the FIRMWARE.

7.1.4. STOVE STATUS MENU

In this menu, you can check the correct functioning of the most important components of the pellet stove and some values which distinguish its correct functioning.

To enter this menu, proceed as follows:

1. Keep button P4 pressed for 2 seconds, CLOCK SETTING MENU will appear.
2. Press button P4 4 times: the display will show Stove STATUS MENU
3. Access using button P6: the display will show the desired screen.
4. Confirm with button P6 to return automatically to MENU 05 Stove STATUS. This menu is utilized by the TAC (Technical Assistance Center) when a problem occurs and by the customer when loading pellets into the hopper manually.

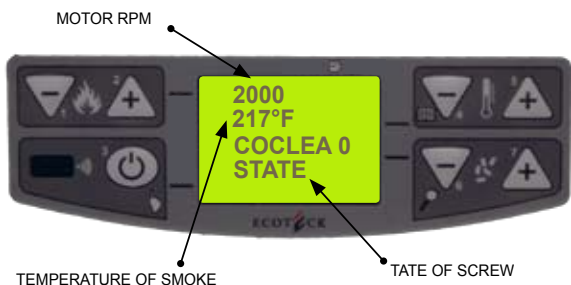

7.1.5. WORKING HOURS MENU

The WORKING HOURS Menu shows the total hours of work by the stove. In some cases, the working hours may not be zeroed. i.e. numbers similar to 5000/15000/25000 may be shown; the technician will zero set these numbers when lighting the stove for the first time. This does not mean that the stove has worked for all those hours. It is only a setting given by the programme during the first inspections in Ravelli, before the stoves are packaged and sent.

To enter this menu, proceed as follows:

1. Keep button P4 pressed for 2 seconds: CLOCK SETTING MENU will appear.
2. Press button P4 5 times: the display will show WORKING HOURS MENU.
3. Access with button P6: the display will show the screen desired.
4. Confirm with button P6 to return automatically to MENU' 06 WORKING HOURS MENU.

7.1.6. SEE SETTINGS MENU

In this menu you can check the values of the parameters set in the control unity.

This menu is used when the Technical Assistance Center has to understand the parameters set in the machine, to find any modifications to improve the functioning of the stove.

To enter this menu, proceed as follows:

1. Keep button P4 pressed for 2 seconds: CLOCK SETTING MENU will appear.
2. Press button P4 3 times; the display will show SEE SETTINGS MENU
3. Access with button P6 or P7: the display will show the screen desired.
4. Scroll using the button P6 to display the parameters set
5. Roll till last parameter with P6 to return automatically to MENU' 04 SEE SETTINGS MENU.

7.1.7. CHRONOTHERMOSTAT SETTING MENU

With the chronothermostat function, programmed switching ON and OFF of the stove for each day of the week can be programmed in two independent time intervals (PROGRAM 1 and PROGRAM 2).

To enter this menu, proceed as follows:

1. Keep button P4 pressed for 2 seconds, CLOCK SETTING MENU will appear,
2. Press button P4 once; the display will show CHRONOTHERMOSTAT SETTING MENU
3. Access with button P6: the display will show the screen desired.



If this black segment is not lit up on the display corresponding with the symbol of the clock, it will be anyhow possible to programme it. To activate it, please see the chapter on setting the current day (7.1.2 MENU' 01 SET CRONO) as the value must be other than OFF.

DESCRIPTION OF THE STRINGS:

Description	Values that can be set
START PROG -1	From OFF to 23.50 with step of 10'
STOP PROG -1	From OFF to 23.50 with step of 10'
DAY PROG -1	Between on/off for days 1 to 7
POWER PROG -1	From 1 to 5
SET TAMB PROG -1	From 7° to MAN
START PROG -2	From OFF to 23.50 with step of 10'
STOP PROG -2	From OFF to 23.50 with step of 10'
DAY PROG -2	Between on/off for days 1 to 7
POWER PROG -2	From 1 to 5
SET TAMB PROG -2	From 7° to MAN

START PROG:This parameter shows the switch ON time of programmes 1 and 2.

STOP PROG:This parameter shows the switch off time of programmes 1 and 2

DAY PROG:With this parameter you set in which day you want program 1 and 2 to be active, to set this parameter, proceed as follow:set with botton P5 the days desired (Monday is 1, Tuesday is 2, etc.....) and with botton P4 select ON or OFF; if you select OFF the programming set will not be activated on the days desired; if you select ON the programming will be valid.At the and of this settig, press P6 to go to next step.

POWER PROG:This parameter shows the power the stove is set when starting with CRONO

SET TAMB PROG:This parameter shows the ideal temperature you want to be reached in the room, where the stove is installed, when starting with crono ON.

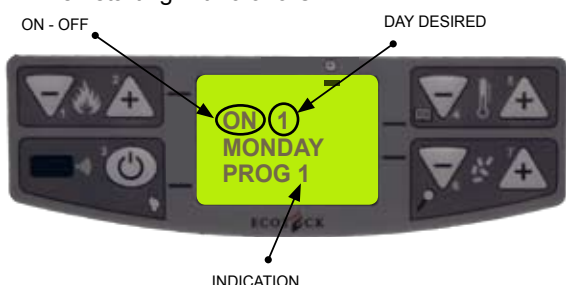

EXAMPLE

If you want the stove to switch ON at 6:00 am and switch OFF at 8:30 am (Program 1) and you want to set a room temperature of 73 °F and to reach such a temperature with power 4, the steps to follow are:

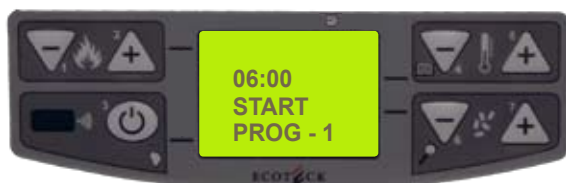

Display this screen as described in chapter 7.1.7. Set the time desired for PROGRAM 1 to go on ON with buttons P4 and P5. Press button P6 to confirm and continue with next screen. In the case of error, press P7 to go back one step.



Set the time desired for PROGRAM 1 to go on OFF with buttons P4 and P5. Press button P6 to confirm and continue with next screen.

At this stage, you have to decide on which days of the week you want the program set above to be active.

Let's simulate that we want PROGRAM 1 is operative on Monday and Wednesday, but not operative on the other days. The settings to be done are as follows:



With button P5 set the day on which you want PROGRAM 1 to be activated (in this case 1, i.e. Monday). At this point, set the value ON/OFF with button P4 which activates/disactivates PROGRAM 1 (MONDAY NOW IS ON).
SUMMARIZING, ON MONDAY THE Stove WILL SWITCH ON AT 6.00 A.M. AND SWITCH OFF AT 8.30 A.M.



ON TUESDAY THE Stove WILL NOT BE SWITCHED ON



ON WEDNESDAY THE Stove WILL BE SWITCHED ON AT 6.00 A.M. AND SWITCHED OFF AT 8.30 A.M.



ON THURSDAY THE Stove WILL NOT BE SWITCHED ON



ON FRIDAY THE Stove WILL NOT BE SWITCHED ON



ON SATURDAY THE Stove WILL NOT BE SWITCHED ON



ON SUNDAY THE Stove WILL NOT BE SWITCHED ON

Confirm with botton P6 to get into next step
At this point we select the power of PROG -1



Set the desired power for PROGRAM 1 with buttons P4 and P5.

After you selected the power you have to decide for the room temperature desired, independently from the temperature you set during manual starting setting; as soon as the room temperature is reached, the stove will enter into modul or confort clima (if activated)

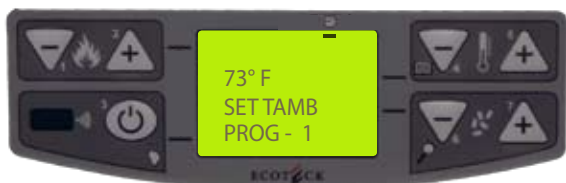

Set the desired temperature with buttons P4 and P5.

Do the same operations, changing times and days of activation for PROG-2 as well.

IMPORTANT !

PLEASE CECK THAT FIREPOT IS CLEANED BEFORE START UP OF THE Stove

8. Description of the symbols and displays

8.1. Symbols

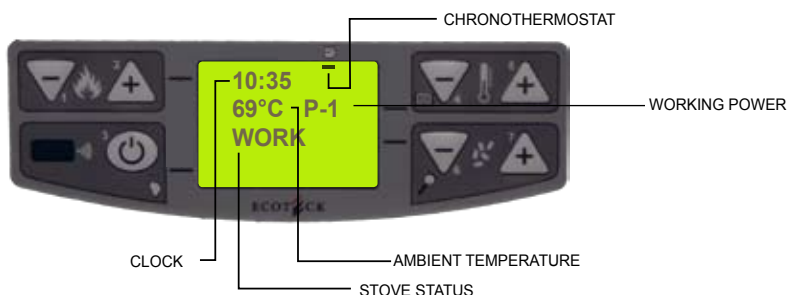

9. Description of the functions

9.1. Modification of the working power

To modify the working power, press button P1 to enter the appropriate menu and with buttons P1 and P2 set the desired power from 1 to 5. By increasing the power, the consumption of pellets and the speed of the heat exchanger fan increase. The power setting cannot be modified in the MODULATION WORK phase

9.2. Modulation

During the working phase, the aim of the stove is to reach the ambient temperature set; when the set temperature is reached, the stove will enter into MODULATION WORK mode. During this phase the stove works at power 1, consumption of the fuel will be minimal and the ambient fan will function at minimum power.

9.3. Comfort clima

To enter in this program, press simultaneously buttons P4 and P6. When the room temperature is reached the stove reduce to the POWER 1 for few minutes to be sure that the room temperature remain, and then the stoves goes automatically in ECO- STOP (the stove will shut down)



to activate to ECO STOP program, press button P5 to set a value other than OFF



The value set (can be 36 or 38 or 2-4-6 depending from version of software) has activated the Comfort Clima function.

FUNCTIONING:

The value sets the temperature the stove goes back on ON again. Example:

- room temperature set at 72°F

- Comfort Clima value set at 36 (or 2)

with this setting, the stove will switch OFF when 72°F is reached and will be switched back on again when the room temperature is 69°F.

If confort value set is 38 (or 4) the stove instead will go back on ON at 67°F



The modulation phase is reached, as the set room temperature has been reached.

If the temperature is maintained for about 4 minutes, the stove will shut down.



After the switching OFF phase, the display will show ECO STOP. The stove will remain in this state until the temperature drops to 69 ° F(or 67 ° F) and only then will the ignition phase be restarted.

The functioning of the stove in COMFORT CLIMATE mode can start up the phase of ignition and switching off several times through the day: this can compromise the duration of the ignitor for the automatic ignition of the stove.

IMPORTANT !

USING THIS MODE, YOU HAVE TO MAKE SURE EACH TIME THAT AFTER THE Stove IS AUTOMATICALLY SWITCHED OFF, THE FIRE POT REMAINS CLEAN IN ORDER TO GUARANTEE CORRECT AUTOMATIC IGNITION.

9.4 Modifications of the room temperature setting

The mode of functioning of the stove with the control of ambient temperature can be divided into two types:

- with room sensor supplied (not available on INSERTS) positioned on the back of the stove.
- with external thermostat (not supplied)

MODE WITH ROOM SENSOR SUPPLIED

If the room sensor supplied is used, the room temperature will be shown on the display.

To set the desired temperature (modification of the room temperature setting), press button P4 to enter the appropriate menu and with buttons P4 and P5 adjust the desired value. When temperature it is reached on the display, MODULATION WORK will appear on the screen and in this case the stove will reduce the consumption of pellets to a minimum, reducing heating power.

EXTERNAL THERMOSTAT MODE

If an external thermostat is used, correctly connected to the board as shown in the electric wiring diagram(see page 27), the room temperature will be no longer shown on the display that will show instead T ON, when the contact is close, or T OFF, when the contact is open.

REMARK: TO ACTIVATE THE EXTERNAL THERMOSTAT, PRESS BOTTON P4 AND THEN REPEATEDLY ON P1 TILL YOU REACH THE SETTING "EST" ON THE DISPLAY.CONFIRM WITH BOTTON P7

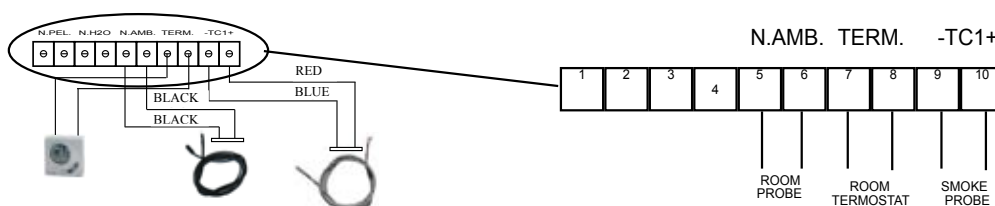

The room temperature will be regulated directly by the wall-mounted thermostat. When the temperature set is reached, the display will show MODULATION WORK: the stove will work then at lower power to reduce the consumption of the pellet.Ifmode COMFORT CLIMA is activated, the stove will shut down.

Confort clima setting is active also with external thermostate

WE ADVISE A ROOM TERMOSTATE WITH OFF-SET WITH OF MINIMUM 6°F IF WE WANT ACTIVATE CONFORT CLIMA,PROPERLY.

9.5. Setting the pellet-air mixture

The setting the pellet-air mixture allows easy adjustment of the rate of draught of air and the quantity of pellets loaded. This allows regulating the combustion based on the draught of the flue and the hardness and quality of the pellets. To access regulation, press buttons P6 and P7 at the same time and the following strings will appear on the display:



With buttons P6 and P7, the value of the draught is modified; with buttons P4 and P5, the quantity of pellets fed is modified (the value shown during the modifications only indicates a percentage value which acts on the parameters of default set in the electronic board).

These values must be modified if there is poor combustion if pellets other than those used during the setting of the stove when installed.

9.6. Automatic loading of the auger

To automatically load the auger (when the stove is new the auger is empty), then proceed as follows:

1. Keep button P4 pressed for 2 seconds. CLOCK SETTING MENU will appear.
2. Press button P4 4 times; the display will show Stove STATUS MENU



THE AUGER IS IDLE

PRESS BUTTON P5 TO ACTIVATE THE AUGER



AUGER ACTIVATED

Repeat the operation several times until you can see the pellets fall into the fire pot.
This operation can be performed only if the stove is OFF or in FINAL CLEANING.

IMPORTANT !

AFTER HAVING LOADED THE AUGER, EMPTY THE FIRE POT INTO THE TANK BEFORE SWITCHING ON.

9.7. Switching the stove ON and OFF

Before switching the stove ON, proceed as follows:

1. Insert the main supply cable.
2. Place the switch on the back of the stove in position 1.
3. Check that the appliance is connected to the flue.
4. Load the tank with pellets.
6. Load the auger as described in chapter 9.6
7. Press button P3 for 3 seconds.

At this point the stove will switch ON.

The following messages will appear on the screen (depending on the models, the messages are not always the same).

- LIGHT
- WAIT FOR FLAME
- FLAME PRESENT
- WORKING

During the working phase, the following settings should be checked:

- POWER SETTING as described in chapter 9.1
- ROOM TEMPERATURE SETTING as described in chapter 9.4
- PELLET/AIR MIX SETTING as described in chapter 9.5

Switching the stove OFF, proceed as follows:

1. Press button P3 for 3 seconds.
2. Stove will go into final cleaning stage.
3. DO NOT unplug stove or open door until unit is fully cooled down.

9.7.1. Operating precautions

- In case of faulty operation turn the stove OFF pressing button no. 3.
- Do not manually load the fire pot with pellets.
- To much of unburned pellets inside the fire pot, after repeatedly trying to light the stove, must be removed before further attempts.
- Do not use any fuels other than wood pellets.
- Should the ignition system be faulty, do not attempt to light the stove using flammable materials.

9.8. Remote control

IR receiver for remote control (12 volts batteries code LRV08 not included)



- **P1 - P2** **Temperature setting:** allow setting the value of the desired room temperature from a maximum of 104°F to a minimum of 42°F.
- **P4 - P5** **Power setting:** allows setting the value of the working power from a minimum of 1 to a maximum value of 5 displays.
- **P1 + P4** **ON/OFF:** pressed for 2 seconds, they switch ON and OFF the stove manually.

9.9. Synthetic table of phases

PHASE	DESCRIPTION
FINAL CLEANING	The stove is switching off, the cooling phase is not yet completed
ON	The ignition phase has started, the pellets are loaded into firebox
WAITING FOR FLAME	The pellet is lighted by the hot air passing trough the ignition candle
FLAME PRESENT	The flame is visible in the fire pot
WORKING	The stove has completed lightening phase; you can modify working power
MODULATION WORKING	The room temperature set has been reached
ECO STOP	Comfort Climate activated, temperature set has been reached, the stove is OFF
T ON	The room temperature sensor is OFF or an external thermostat has been connected
COOLING/WAITING FOR START	The stove is in cooling DOWN: when stove is cooled down the stove start automatically.
COOLING/WAITING FOR RESTART	The stove is in the cooling DOWN: when stove is cooled down the stove restart automatically.
ON/WAITING FOR RE-START	The switch ON phase when the stove is warm started. The operation is same of phase ON
HOT SMOKE	The max temperature of smokes is reached: to cool down temperaure the stove reduce feeding of pellets and air draft at PT 01
OFF	The stove is off

IMPORTANT !

IF DISPLAY SHOWS "HOT SMOKE" THERE CAN BE PROBLEMS IN THE COMBUSTION OF PELLET. PLEASE CONTACT T.A.C for survey.

9.9. Description of alarms

WARNING	REASON	SOLution
PELLETS FINISHED ALARM	• The pellet hopper is empty	• Check whether there are pellets in the hopper
	• The gearmotor does not load pellets.	• Empty the hopper to check that no objects have fallen inside which could prevent the correct functioning of the screw
	• Poor pellet loading	• Adjust the pellet setting
		• If the problem continues, contact the area Technical Assistance Center.
BLACK - OUT	• No electricity supply during working phase	• Press the OFF button and repeat switching ON the stove
		• If the problem continues, contact the area Technical Assistance Center.
NO IGNITION ALARM	• The pellet hopper is empty.	• Check if there are pellets inside the hopper.
	• Setting of pellets and of air intake during ignition phase insufficient.	• Contact local Technical Assistance Center.
	• The resistance for lighting is defective or not in position	• Contact local Technical Assistance Center.
ALARM LOW FLAME	• The pellet hopper is empty.	• Check if pellet is in the hopper
	• Bad setting of pellet and air on ignition phase	• Contact local Technical Assistance Center
ALARM FAN RPM	• The revolution of smoke fan lowering more then 15% of speed due to fan congestion	• Contact local Technical Assistance Center
ALARM FAN BROKEN	• Smoke extractor encoder is not functioning or not correctly connected	• Contact local Technical Assistance Center
	• No electricity supply to smoke fan	• Contact local Technical Assistance Center
	• The smoke fan is blocked	• Contact local Technical Assistance Center
DEPRESSION ALARM	• The combustion chamber is dirty • Front door, pellet hopper door open	• Follow the cleaning operations of the stove as per the instructions in the booklet. Close the door and reset
	• The flue is blocked	• Check that the flue is clear and clean
	• The vacuum switch is malfunctioning	• Please contact local Technical Assistance Center
THERMAL ALARM WITH RESET	• The thermostat with manual reset has intervened	• Reset the thermostat pressing the button on the back of the stove (see Fig. below).
	• The centrifugal fan is defective	• Please contact local Technical Assistance Center
	• Combustion in the fire pot is not optimal	• Switch OFF the stove, clean the fire pot and regulate combustion with the setting of the pellets.
		• If the problem continues, contact the area Technical Assistance Center.
HOT SMOKE ALARM	• Combustion in the fire pot is not optimal	• Switch OFF the stove, clean the fire pot and regulate combustion with the setting of the pellets.
	• The centrifugal fan is defective	• Contact local Technical Assistance Center
		• If the problem continues, contact the area Technical Assistance Centre.
SMOKE SENSOR ALARM	• The smoke sensor is malfunctioning	• Please contact the local Technical Assistance Center
	• The smoke sensor has been disconnected from the board	• Please contact the local Technical Assistance Center
ALARM AUGER BLOCKED	• The auger does not load pellets	• Please contact the local Technical Assistance Center

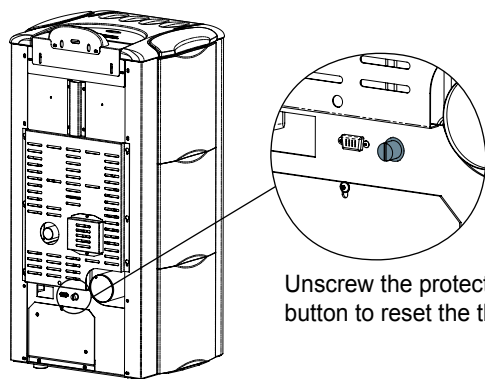

Unscrew the protection cap and press the button to reset the thermostat alarm.

By pressing the button P3 on the display, the alarm can be reset. Try and repeat lighting after the cooling phase.

9.10. Description of auger and door safety device

SAFETY DEVICE FOR AUGER WHEN OPENING HOPPER DOOR

When you are feeding wood pellet into the hopper, or you just need to check into hopper the level of wood pellet, for your safety as soon as you will open pellet door, the auger will stop automatically the feeding of the pellet; consequently, if the stove is in “WORKING” conditions, do not leave the hopper door (see ref B) open longer then one minutes. In case that the door will remain open longer the 60”, the stove will shut down completely. The display will show “NO DEPRESS” (see ref. C). To restart the stove press ON.

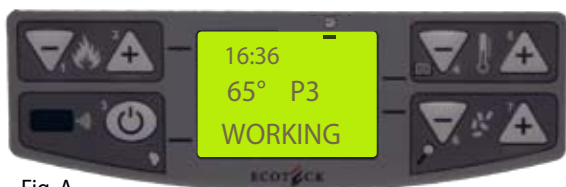

Fig. A

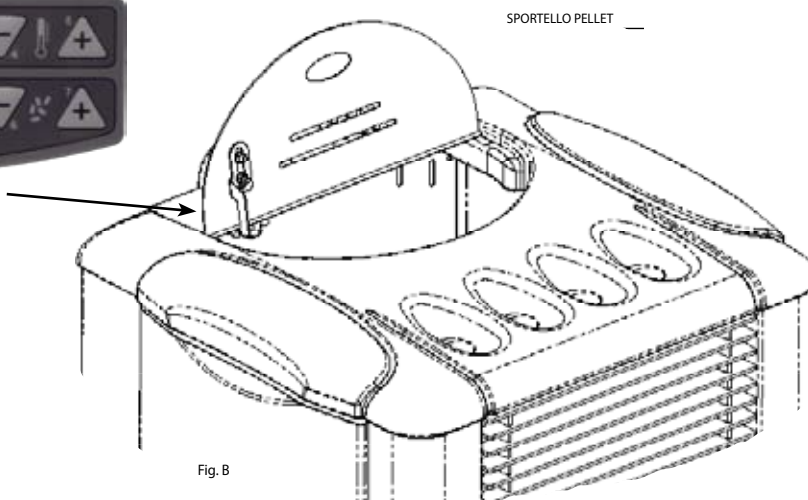

Fig. B

SAFETY DEVICE FOR OPENING OF FRONT DOOR

When the stove is in “WORKING” conditions, every time the front door will be open, the stoves safety system will start a count down for a period set with parameter PR35 (company setting is 10”); After set time, the stove will shut down and display will show “NO DEPRESS”(see ref C); to reset alarm, please close the door and then press button 3 for reset; for restarting the stove press again botton 3

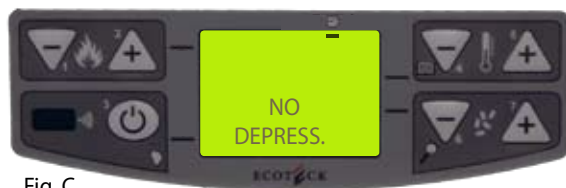
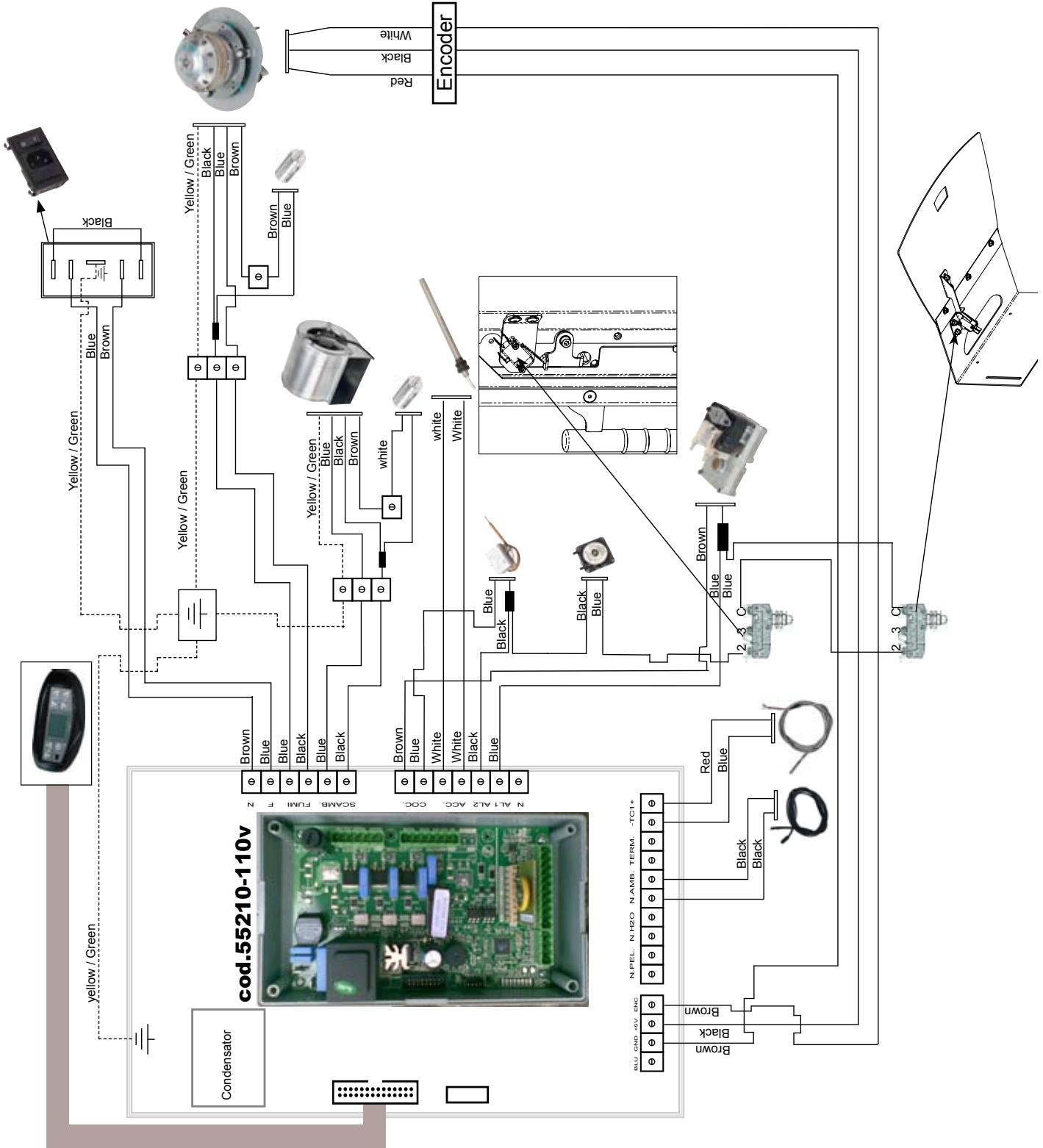

Fig. C

10. The electrical wiring diagram

10.1. The electrical wiring diagram for air stove



11. Maintenance

Before carrying out any maintenance operation on the stove, please take the following precautions:

- Make sure that all the parts of the stove are cold
- Make sure that the ashes are completely extinguished
- Make sure that the general switch is in the zero position (off)
- Make sure that the plug is disconnected from the socket, thus avoiding accidental contacts.

IMPORTANT

Please follow the instructions for cleaning shown below carefully! Failure to observe them may lead to problems in the functioning of the stove.

11.1. Cleaning the surfaces

To clean the surfaces on the painted metal parts, use a wet cloth in water or at the most, water and soap.

Important: the use of aggressive detergents or diluents can damage the surfaces of the stove.

11.2. Cleaning the fire pot before and after each lighting

You must check that the fire pot, where the combustion takes place, is clean and that no waste or residue blocks the holes, in order to always guarantee excellent combustion of the stove, thus avoiding possible overheating. Overheating could cause changes in the color of the paint or flaking of the door as well as failing to light the stove.



Clean burnpot with all the holes clearly visible



Burnpot needing cleaning with the holes blocked by ashes

Only a clean fire pot can guarantee that the pellet stove functions without problems. During functioning, deposits may be formed, which have to be immediately eliminated.

It is easy to see when the fire pot has to be cleaned! It only needs a glimpse, each day, before switching on. For minor cleansing, it can be left in the stove, but if the residue is difficult to remove, it has to be extracted from its housing and the waste scraped out.

The residue of ash depends on the quality of pellets used.

Important: even with a new batch of pellets, although using the same brand, there may be differences during combustion and therefore they may dirty to a greater or lesser extent.

Correct cleaning, done on a daily basis, allows the stove to burn optimally and to have a good yield, avoiding malfunctioning which in the long term could require technical assistance to reset the stove.

11.3. Cleaning the FIREX 600



All Ravelli products have a combustion chamber made with FIREX 600, a material based on vermiculite, the result of research and development by Ravelli. The main features of FIREX 600 are resistant to heat, its lightness and excellent insulating capacities, improving the combustion and performance of the stove.

During combustion, FIREX 600 turns white, due to an effect called PYROLYSIS, making the flame clear and shining. If the combustion is regulated in an optimal way, the FIREX 600 interior always remains clean and white.

The condition of FIREX 600 is therefore a thermometer to understand whether the combustion is good or not.

FIREX 600 LIGHT – EXCELLENT COMBUSTION

FIREX 600 DARK – POOR COMBUSTION

Firex 600 does not require special maintenance, it only has to be dusted with a brush to remove the ash that is deposited during combustion. Abrasive sponges to clean to most resistant waste should not be used as they could compromise the thickness of the FIREX600 panel, creating critical points of breakage.

The tube of the vacuum cleaner should not be used in direct contact with FIREX 600.

Wet cloths should not be used to clean FIREX 600.

FIREX 600 is resistant to heat but can still break; handle with care if moved.

FIREX 600 may show a slight abrasion after a few hours of functioning, this is perfectly normal as the flame creates microgrooves in the panel without compromising it.

The duration of FIREX 600 depends only on how maintenance is carried out.

The pellet stove is a generator of heat with a solid fuel and as such requires servicing by qualified personnel at least once a year at the start of the season. This maintenance has the purpose of ascertaining and ensuring the perfect efficiency of all the components.

We recommend you draw up an annual contract for maintenance of the product with your installer/dealer.

11.4. Disposal of Ash

- Ash should be placed in a metal container with a tight fitting lid.
- The ash should be placed on a non-combustible floor, or ground well away from combustible materials pending final disposal.
- Before final disposal, the cinders must be thoroughly cooled!

11.5. Cleaning the Vent Pipe

- Soot and fly ash formation need to be removed, the products of combustion will contain small particles of fly ash. The fly ash will collect in the exhaust venting and restrict the flow of gases. Incomplete combustion occurs during start-up and shut-down or incorrect operation of the room heater will lead to some soot formation, which will collect in the venting system. The venting system should be inspected once a year. Clean if necessary.

- Ensure stove and vent pipe are cool prior to cleaning.
- Make sure vent cap is free of all debris.
- Check the vent for creosote. Build up higher than 1/4" inch must be removed.
- On vertical vented stoves the dirtiest spot is often the Tee. The Tee has a built in clean out cover, remove cover and clean out.

12. Warranty

12.1. Certificate of Warranty

Ravelli thanks you for the confidence you have placed in it with the purchase of one of our pellet stoves and invites the purchaser to:

- examine the instructions for the installation, use and maintenance of the stove.
- examine the conditions of warranty shown below.

The enclosed coupon must be filled in and signed by the installer. If this does not occur, the product will not be covered by the warranty.

12.2. Conditions of Warranty

The limited guarantee covers defects of manufacturing materials, on condition that the product has not been broken due to an incorrect use, carelessness, wrong connections or errors of installation.

The following are not covered by guarantee:

- vermiculite (Firex 600);
- the glass of the door;
- the fibre gaskets;
- the painting;
- the stainless steel combustion basket;
- the resistance;
- the cast majolica
- any damage caused by inappropriate installation and/or handling of the stove and/or shortcomings by the consumer.

The use of poor quality pellets or of any other material could damage components of the stove causing the termination of their warranty and the annexed responsibility of the manufacturer.

The pellets which meet the standards listed in the chapter on them should be used.

All damage caused by transport are not acknowledged, therefore please carefully check the goods on receipt, immediately advising the dealer of any damage.

All the manufacturer's warranty is shown here and no complaint may be made to the manufacturer according to any other warranty, report or request.

The warranty coupon must be detached and sent to the following address within thirty days of purchase:

Ravelli s.r.l via Kupfer 31 25060 Palazzolo sull'Oglio (BS), Italy

12.3. Information and problems

For any information or problems, please contact your dealer or service center, the only people who can meet any request you may have or, if necessary, who can intervene directly.

Instructions for 6 keys display for model Francesca

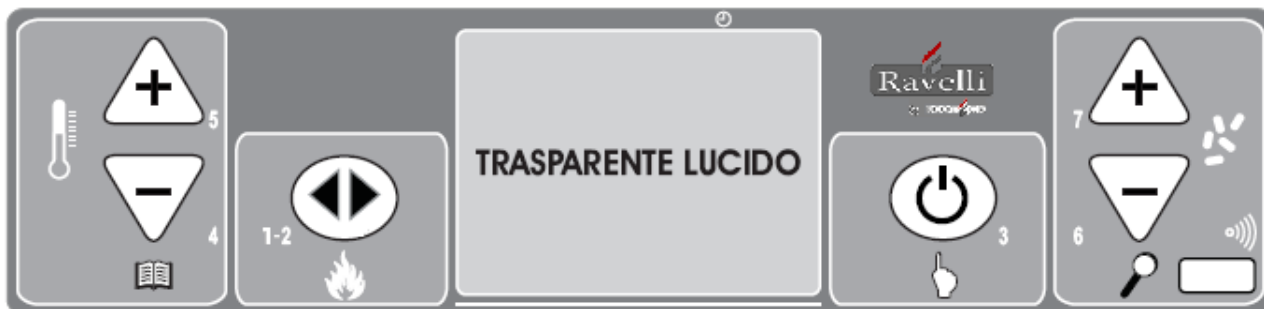

The new model Francesca equipped with a dedicated display with 6 keys. The functions in the motherboard are identical to those available for the display 7 keys used for the classic air stoves. To access to the individual functions follow the procedures outlined in paragraph 7th of the attached generic manual “classic line, flow line and design line”, no matter the position of the keys on the display but their number.

In the 6 keys display, the buttons P1 and P2, is dedicated to setting the power of work, have been unified into a single button P1-2.

Description of the functions of the 6 keys display

- P1–P2 : button to increase or decrease working power (ex.: P1-P2-P3-P4-P5-P1-P2...)
- P3 : button to switch ON or OFF the stove
- P4 : button to lower set room temperature
- P5 : button to increase set room temperature
- P6–P7 : multifunction button



Ravelli srl

Via Kupfer, 31 - 25036 Palazzolo sull'Oglio / BRESCIA - ITALY

Tel. +39.030.7402939

Fax. +39.030.7301758

Internet : www.ravelliguop.it

E-mail : info@ravelliguop.it

Ravelli and does not assume any responsibility for any errors in this booklet and considers itself free to make any variations to the features of its products without notice.