



 *Summerset*<sup>®</sup>  
PROFESSIONAL GRILLS

# ABOUT SUMMERSET

Summerset Professional Grills offers a complete line of stainless steel grills, grill carts, BBQ islands, fire pits, doors, drawers, components and more. Our commitment to quality is reflected in the craftsmanship of our product and is fully supported by the Summerset Warranty.

## OVER 20 YEARS OF LEADERSHIP

Summerset Professional Grills is a company born of experience. With 20 years of leadership in branding and manufacturing, our core focus is clear — to provide consumers with exceptional service and outstanding quality at a great value.

## PRODUCTS FOR EVERY BUDGET

Summerset strives to meet every outdoor living expression. We offer a wide range of affordable products from our Sizzler Series all the way up to our new AMG Multi Fuel Grill, without sacrificing an ounce of quality. No matter the budget Summerset will deliver an outdoor experience that will create fond memories for years to come.

## SUPERIOR QUALITY

Here at Summerset we pride ourselves on using only the best materials. All our products are made with the highest—grade stainless steel available, designed to withstand the high temperatures and greasy environments of outdoor cooking. We strive to maintain excellence in all we do and the result is a product you can count on.



GRILLS



# SIZZLER

Quality you can afford. The Sizzler Series is a premium product at an unbeatable price. Constructed in all #443 stainless steel and designed with careful precision to ensure optimal airflow and even heating, this grill gives its higher-priced competitors a run for their money in both durability and grilling performance. The Sizzler will impress the most discriminating of grillers.



SIZZLER 26" GRILL



SIZZLER 32" GRILL



SIZZLER 40" GRILL



SIZZLER CART

- #443 Stainless Steel Construction
- Double-Lined Hood
- 8mm Cooking Grates
- 12,000 BTU Stainless Tube Burners
- 15,000 BTU IR Back Burner
- Flame Thrower Ignition
- Manual Flash Tube Ignition
- Easy-Clean Briquette System
- Built-In and Cart Models Available
- Matching Side Burner Available
- Rotisserie Kits Available
- 15,000 BTU Drop-In Sear Burner Available
- 14,000 BTU Cast Stainless Burners Available

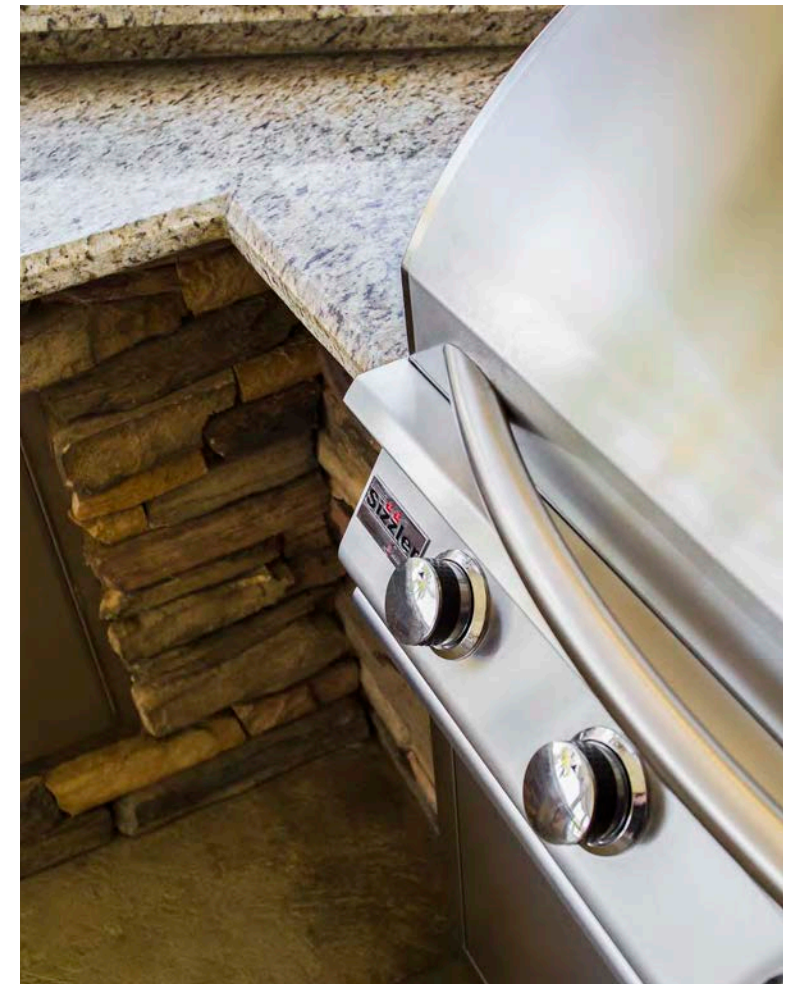
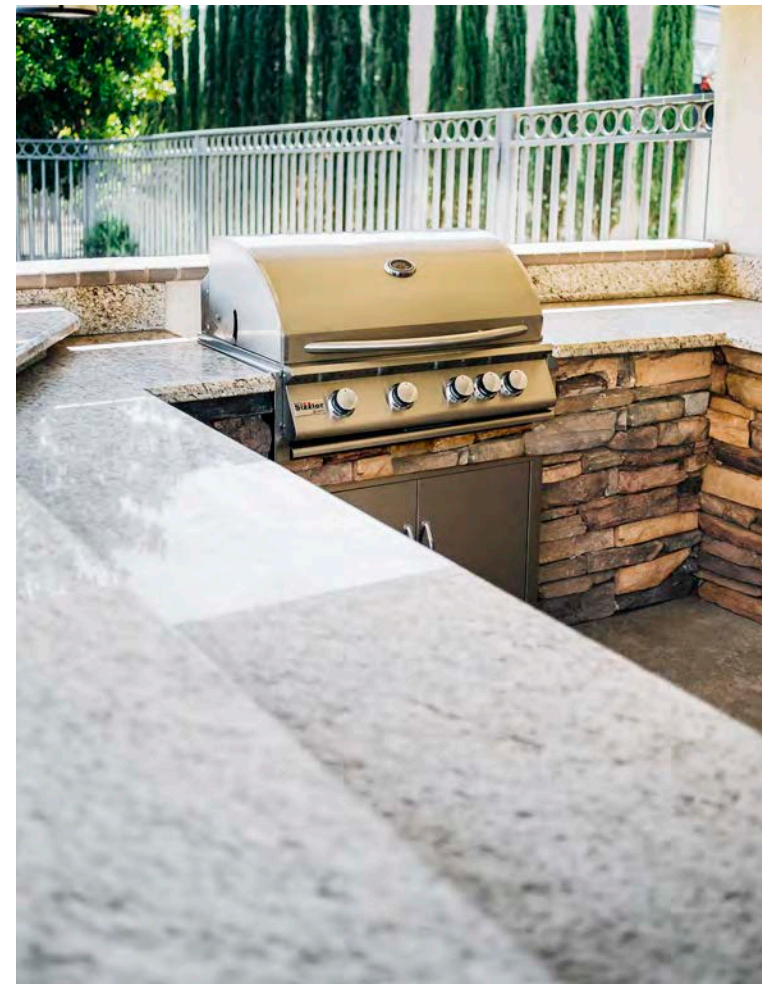

# SIZZLER PRO

The all new Sizzler Pro Series combines features, quality construction and affordability. Based on the same sleek design of our classic Sizzler, with the addition of interior and exterior lighting, 14,000 BTU cast burners and heat zone separators, this grill really sets itself apart. And the best part is... it won't break your wallet.



SIZZLER PRO 32" GRILL



SIZZLER PRO 40" GRILL



SIZZLER PRO CART

- #443 Stainless Steel Construction
- Double-Lined Hood
- 8mm Cooking Grates
- 14,000 BTU Cast Stainless Burners
- 15,000 BTU IR Back Burner
- Heat Zone Separators
- Exterior LED Lighting
- Interior Cooking Lights
- Flame Thrower Ignition
- Manual Flash Tube Ignition
- Easy-Clean Briquette System
- Built-In and Cart Models Available
- Matching Side Burner Available
- Rotisserie Kits Available
- 15,000 BTU Drop-In Sear Burner Available



# TRL/TRLD

The TRL is a fully loaded workhorse, a grilling classic packed with luxury features. Complete with interior lights, exterior LEDs, rear infrared burner, rotisserie set, flame thrower valves, easy-clean briquette burner covers and plug-and-play infrared sear zone options, the TRL makes professional grilling easy. With a commercial-grade stainless steel construction and 16-gauge stainless steel burners backed by a lifetime warranty, this grill is built to last.



TRL 32" GRILL



TRL 38" GRILL



TRLD 44" GRILL



TRL/TRLD CART

- #304 Stainless Steel Construction
- Double-Lined Hood
- 8mm Cooking Grates
- 18,000 BTU #304 Stainless Burners
- 15,000 BTU IR Back Burner
- Flame Thrower Ignition
- Exterior LED and Interior Halogen Lighting
- Easy-Clean Briquette System
- Rotisserie Kit Included
- 18,000 BTU Drop-In Sear Burner Available
- Built-In and Cart Models Available
- Matching Sear Burner Available
- Matching Double Side Burner Available
- 20,000 BTU Cast Stainless Burners Available

## DELUXE FEATURES

- 20,000 BTU Cast Stainless Burners
- Heavy-Duty 9mm Cooking Grates
- Heat Zone Separators

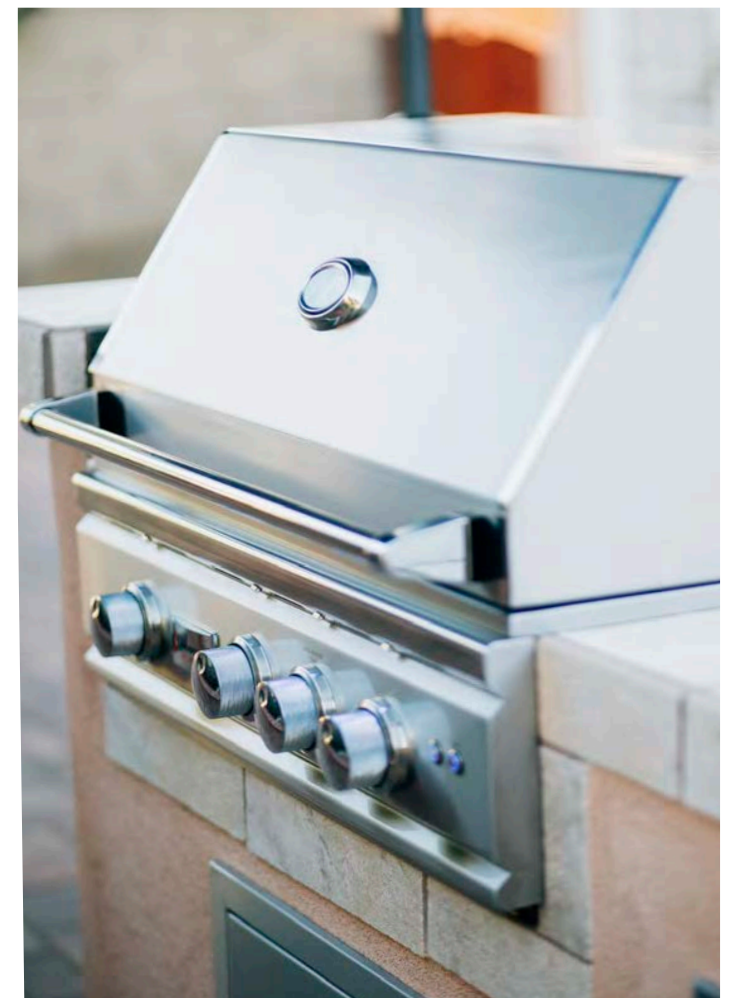

# ALTURI

The Alturi Series can be summed up in one word — luxury. Designed with elegance, fueled with raw power and loaded with every feature, this grill sets the bar for luxury outdoor cooking. Details like the angle-mounted interior lights, rotisserie storage and spring-assisted hood provide ultimate convenience, while its solid #304 stainless steel construction and high BTU Red Brass burners - the most durable in the market - guarantee lasting performance. When it comes to performance, quality and style, Alturi truly stands alone.



ALTURI 30" GRILL



ALTURI 36" GRILL



ALTURI 42" GRILL



ALTURI CART

- #304 Stainless Steel Construction
- Double-Lined Hood w/ Spring Assist
- Heavy-Duty 9mm Cooking Grates
- 26,000 BTU Main Burners
- 15,000 BTU IR Back Burner
- 7,000 BTU Smoker Burner\*
- Interior Halogen Lighting
- LED Front Panel Lighting
- Heat Zone Separators
- Easy-Clean Briquette System
- Flame Thrower Ignition
- Rotisserie Kit Included
- 26,000 BTU Drop-In Sear Burner Available
- Matching Side Burner Available
- Matching Double Side Burner Available
- Built-In and Cart Models Available
- Red Brass or Stainless Tube Burners Available

\*Available on 30" and 42" models



# BUILDER GRILL

The Summerset Builder grill has been specially designed to accommodate all types of multifamily and commercial applications. Whether it is an apartment community, hotel, or country club, these environments get a great deal of extra use. Donning the same beefed-up body as our luxury Alturi series, the Builder Grill is made with solid #443 stainless steel construction, 9mm cooking grates, and extra thick 14 gauge stainless steel burner covers. Available in both built-in and pedestal models, this grill is the perfect option for any commercial application.



BUILDER GRILL



BUILDER GRILL PEDESTAL

- #443 Stainless Steel Construction
- Double-Lined Hood
- Heavy-Duty 9mm Cooking Grates
- 26,000 BTU #304 Stainless Burners
- Flame Thrower Ignition
- Heavy-Duty 14 Gauge Flame Tamers
- Locking Drip Tray
- Heavy-Duty Anti-Theft Knobs
- LP Conversion Kit Included
- Built-in, Cart, and Pedestal Models Available
- Gas Timer Available





A close-up photograph of a charcoal grill. The grill is filled with dark, glowing charcoal briquettes. Some briquettes are in the foreground, while others are in the background. A fire is visible in the background, with bright orange and yellow flames. The grill is made of metal and has a grate. The overall scene is warm and inviting, suggesting a barbecue or outdoor cooking.

**AMERICAN**  
MUSCLE GRILL

# AMERICAN MUSCLE GRILL

We can argue all day about what fuel is “best” for grilling, but now we can put an end to all that. Instead, you can rev up this multi-fuel monster and enjoy all of the benefits of gas, charcoal, lump coal, wood chunks and infrared - all in a single grill. This patent-pending multi-fuel design offers the griller ultimate variety and convenience. Use all of these fuels simultaneously, or choose the perfect match for your meal. You can cook with gas, or simply use it to ignite the solid fuel of your choice in just seconds - also reload or switch fuels at any time without disturbing the cooking process. If alternative fuels aren't your thing, don't worry. The AMG has gas covered, with over 100,000 BTUs of horsepower and a patent-pending heat dispersion design to get the job done right. Whatever the situation, this grill will not only accommodate, it will revolutionize your grilling experience.



36" AMERICAN MUSCLE GRILL



AMERICAN MUSCLE GRILL CART

- #304 Stainless Steel Construction
- 16 Gauge Double-Lined Hood With Spring Assist
- Dual Hood Vents For Heat Control
- Full Width Hood Handle
- 22,000 BTU Main Burners
- 14 Gauge #304 Stainless Steel Burners
- 12 Gauge #304 Burner Covers
- 9 Gauge Reversible V-Shaped Grates
- Flame Thrower Valve Ignition
- Simultaneous Gas And Solid Fuel Capability
- Patented 12 Gauge Solid Fuel Trays
- Grate Lifting Tool For Solid Fuel Refilling During Use
- Dual Interior Cooking Lights
- Exterior LED Lighting
- Easy-Clean Drip Pan With Drain System
- Built In Rotisserie Spit Storage
- Heavy-Duty Rotisserie Kit With 100 lb. Capacity Available
- 22,000 BTU Drop-n Sear Burner Available
- Matching Power Burner Available
- Matching Island Components Available
- Built-In And Cart Models Available
- Made, Designed, Tested and Serviced in the USA





SIDE BURNERS

# SIDE BURNERS

Here we've combined the comfort of an indoor kitchen range with all the benefits of being outside. Specially designed for performance and function, a Summerset side burner is the perfect addition to your outdoor kitchen. Commonly used for finish cooking, sauces, or heating foods that require lower, more controlled temperatures than your grill, a side burner offers the convenience of range top cooking and grilling simultaneously. Find the perfect side burner for your outdoor kitchen with five professional lines to choose from: Sizzler, Sizzler Pro, TRL, Alturi, and AMG. All Summerset side burners feature stainless steel construction, heavy stainless steel grates, and up to 60,000 BTUs of power - all packed in a sleek design and backed by an unbeatable warranty.

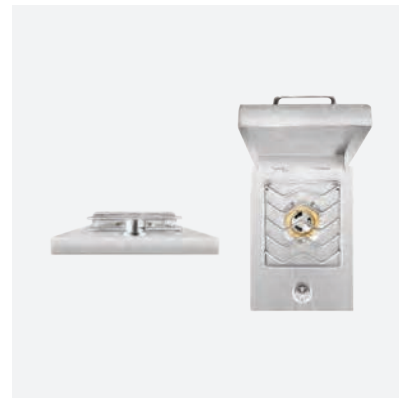

**SINGLE SIDE BURNER**  
SSSB-1  
Total BTUs: 15,000  
Cooking Surface: 9<sup>1</sup>/<sub>2</sub> x 9<sup>1</sup>/<sub>2</sub>

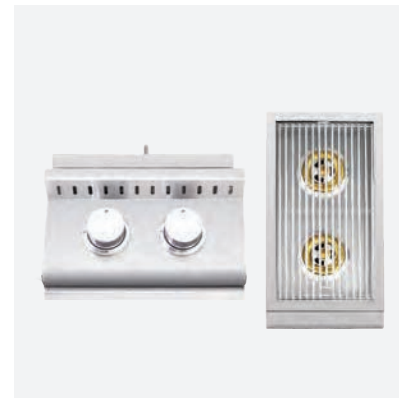

**SIZZLER DOUBLE SIDE BURNER**  
SIZSB2  
Total BTUs: 24,000  
Cooking Surface: 19<sup>1</sup>/<sub>2</sub> x 10<sup>1</sup>/<sub>2</sub>



**SIZZLER PRO DOUBLE SIDE BURNER**  
SIZPRO-SB2  
Total BTUs: 24,000  
Cooking Surface: 19<sup>1</sup>/<sub>2</sub> x 10<sup>1</sup>/<sub>2</sub>  
Front Panel LED Lighting



**TRL DOUBLE SIDE BURNER**  
TRLSB-2  
Total BTUs: 30,000  
Cooking Surface: 19<sup>1</sup>/<sub>4</sub> x 11<sup>1</sup>/<sub>4</sub>  
Front Panel LED Lighting



**ALTURI DOUBLE SIDE BURNER**  
ALT-2B  
Total BTUs: 35,000  
Solid Brass Burners  
Cooking Surface: 21<sup>1</sup>/<sub>2</sub> x 11<sup>1</sup>/<sub>2</sub>  
Front Panel LED Lighting



**ALTURI SEAR SIDE BURNER**  
ALT-SS  
Total BTUs: 26,000  
Infrared Burner (Up to 1600°F)  
Adjustable High/Low Technology  
Cooking Surface: 21<sup>1</sup>/<sub>4</sub> x 11<sup>1</sup>/<sub>2</sub>  
Front Panel LED Lighting

**SEAR SIDE BURNER**  
SSEAR-1  
Total BTUs: 26,000  
Infrared Burner (Up to 1600°F)  
Adjustable High/Low Technology  
Cooking Surface: 18<sup>1</sup>/<sub>2</sub> x 11<sup>1</sup>/<sub>2</sub>



**ALTURI SEAR SIDE BURNER**  
ALT-SS  
Total BTUs: 26,000  
Infrared Burner (Up to 1600°F)  
Adjustable High/Low Technology  
Cooking Surface: 21<sup>1</sup>/<sub>4</sub> x 11<sup>1</sup>/<sub>2</sub>  
Front Panel LED Lighting



**AMG POWER BURNER**  
AMGPB  
Total BTUs: 60,000  
Cooking Surface: 13<sup>1</sup>/<sub>2</sub> x 17<sup>1</sup>/<sub>4</sub>  
Cast Stainless Steel Dual Ring Burner  
Removable Center Grate for Wok Cooking  
Front Panel LED Lighting

**POWER BURNER**  
SSPB-1  
Total BTUs: 60,000  
Cooking Surface: 13<sup>1</sup>/<sub>2</sub> x 17<sup>1</sup>/<sub>4</sub>  
Cast Stainless Steel Dual Ring Burner  
Removable Center Grate for Wok Cooking  
Front Panel LED Lighting



**AMG POWER BURNER**  
AMGPB  
Total BTUs: 60,000  
Cooking Surface: 13<sup>1</sup>/<sub>2</sub> x 17<sup>1</sup>/<sub>4</sub>  
Cast Stainless Steel Dual Ring Burner  
Removable Center Grate for Wok Cooking  
Front Panel LED Lighting



COLD STORAGE

# COLD STORAGE



OUTDOOR RATED REFRIGERATOR  
ORFR-2



ALTURI REFRIGERATOR  
ALTRFR-1



SUMMERSET REFRIGERATOR  
SSRFR-1



SUMMERSET REFRIGERATOR  
DOOR SLEEVE  
SSRSL-1 / SSRSL-R



SUMMERSET REFRIGERATOR  
TRIM KIT  
SSRTK-1 / ORFRTK-1

## REFRIGERATION

Enjoy fresh ingredients and chilled beverages with Summerset Stainless Steel Refrigerators. With up to 5.5 cubic feet of storage and glass shelving, these appliances will facilitate food preparation and storage needs for your outdoor kitchen. All Summerset Refrigerators offer durable construction for the outdoors, temperature control, adjustable legs for leveling, and sleek design for function and beauty. Bring the function of your indoor refrigerator outside with matching performance and design.

### OUTDOOR RATED REFRIGERATOR

Storage Capacity: 5.4ft<sup>3</sup>, Full Stainless Steel Construction, Sealed Back For Energy Efficiency, Quick Cool Technology, UL Certified For Outdoor Use, Door w/ Lock & Key, Digital Thermostat

### ALTURI REFRIGERATOR

Storage Capacity: 4.6ft<sup>3</sup>, #304 Stainless door w/ Lock & Key, Glass Shelving, Crisping Drawers, Interior Light

### SUMMERSET REFRIGERATOR

Storage Capacity: 4.6ft<sup>3</sup>, Reversible door w/ Lock & Key, Glass Shelving, Crisping Drawers, Interior Light

### OUTDOOR RATED REFRIGERATOR CUTOUTS

(W) 24 x (H) 33<sup>1</sup>/<sub>4</sub> x (D) 25

### ALTURI REFRIGERATOR CUTOUTS

(W) 22 x (H) 33<sup>1</sup>/<sub>2</sub> x (D) 24

### SUMMERSET REFRIGERATOR CUTOUTS

(W) 22 x (H) 33<sup>1</sup>/<sub>2</sub> x (D) 24



LARGE ICE CHEST  
SSIC-1



SMALL ICE CHEST  
SSIC-2

## ICE CHESTS

With our grills heating things up, we have just what you need to keep cool. Choose between two sizes to optimize your serving station. With up to 40 lbs. of ice capacity, load 'em up with refreshments, snacks or ingredients to make for a good time and easy grilling.



OUTDOOR SINK  
SSNK-2



LIGHTED BEVERAGE CENTER  
SSBCL-1

## BARS AND SINKS

Take your outdoor kitchen to the next level with the Beverage Center. Complete with an ice compartment, sink, towel holder, speed rail with condiment tray and built-in bottle opener, this will make you the best host in the neighborhood. Don't worry, when the sun goes down the LEDs will light it up and keep the party going!



UNDER MOUNT SINK  
SSNK-3



OUTDOOR KITCHEN  
COMPONENTS

# OUTDOOR KITCHEN COMPONENTS

We've recently upgraded our full line of outdoor kitchen components to feature double-lined construction, a heavier-duty flange, and soft closing drawers. Double-lined construction provides the extra insulation and resilience needed against the elements, and a thicker flange provides a sturdy, seamless fit and elegant style that will work with any counter-top and island finish. Soft closures bring the luxury of an indoor kitchen to the outdoor space. Summerset components also feature complete #304 construction, reversible door mounting, magnetic latch, smooth gliding drawers on heavy-duty tracks, and limited lifetime warranty. Sleek and seamless, Summerset components provide an integrated solution that can be personalized to any space.

## ACCESS DOORS

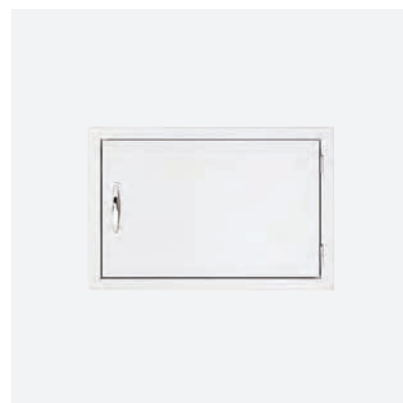

HORIZONTAL DOOR  
SSHD-1



MINI VERTICAL DOOR  
SSMD-1



VERTICAL DOOR  
SSDV-1



30", 36", 42" DOUBLE DOOR  
SSDD-30 SSDD-36 SSDD-42



LARGE VERTICAL DOOR  
SSDVL-1

## STORAGE DRAWERS



SINGLE DRAWER  
SSDR-1



DOUBLE DRAWER  
SSDR-2



TRIPLE DRAWER  
SSDR-3



DOUBLE HORIZONTAL DRAWER  
SSHDR-2



TOWEL DRAWER  
SSTDH-1



UTILITY DRAWER  
SSUD-1



36" AMG STORAGE DRAWER  
AMGSD-36



DOOR/DRAWER COMBOS



DOOR/2-DRAWER COMBO  
SSDC-1



DOOR/3-DRAWER COMBO  
SSDC-3



36" PANTRY AND DOOR COMBO  
SSPC-36



TOWEL/2-DRAWER COMBO  
SSTD-1



TRASH DRAWER/LP DRAWER  
SSTD-1

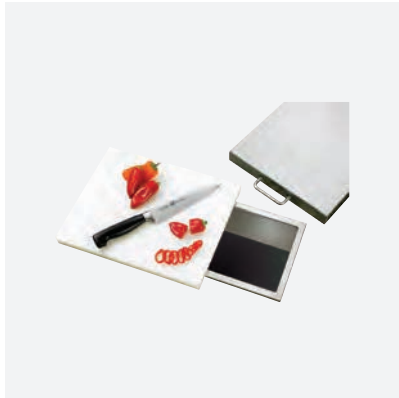

CUTTING BOARD/TRASH CHUTE  
SSTC-1





## MASONRY COMPONENTS

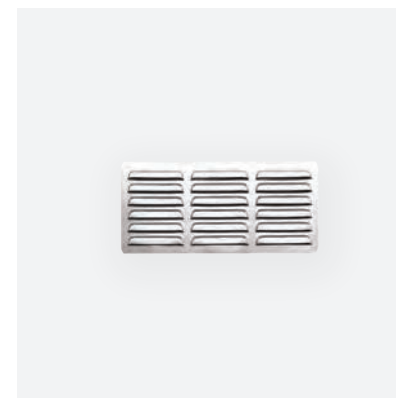

ISLAND VENT  
SSIV-M



DOUBLE DRAWER  
SSDR-2M



TOWEL DRAWER COMBO  
SSTDC-M



LARGE VERTICAL DOOR  
SSDVL-M



TRASH DRAWER  
SSTD-M



DOOR/2-DRAWER COMBO  
SSDC-M



30" DOUBLE DOOR  
SSDD-30M



42" DOUBLE DOOR  
SSDD-42M

# GRILL AND ISLAND ACCESSORIES

## GRILL COVERS

Protect your outdoor kitchen with Summerset Grill Covers. Our heavy-duty PVC covers are 100 percent water-resistant, UV-protected to prevent fading, custom fitted, and feature soft flannel backing (to keep your steel scratch-free). Covers also available for Side Burners and Fire Pits.



GRILL COVER  
GRILLCOV



CART COVER  
CARTCOV

## GRILL & SIDE BURNER LINERS

Summerset Grill Liners are made with #304 stainless steel to protect any outdoor kitchen made of combustible material. The fitted Grill Liners provide an inch of double-walled insulation that blocks the heat from reaching combustible surfaces or framing such as wood or plastic, giving you the freedom to create your outdoor kitchen in the material of your choice.



GRILL LINER



SIDE BURNER LINER

## SMOKER TRAY

Add some pizzazz to an otherwise ordinary meal with the Summerset Smoker Tray. Whether it's mesquite chicken or applewood smoked salmon, the smoker tray is the ultimate meal enhancer that allows for endless flavor options.



SMOKER TRAY  
SSMK-SIZ SSMK-TRL

## SEAR BURNERS

Become the chef you've dreamed of by using Summerset Sear Burners. Our sear burners can replace any main burner position giving you a customizable cooking experience and allowing you to burn and turn the way you want. Crank up the heat and lock in the flavor, leaving your family and friends with a meal they'll never forget.



TRL SEAR BURNER  
SSIRB-L

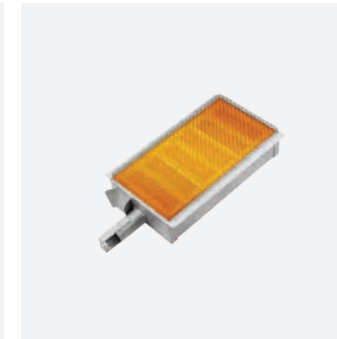

ALTURI SIDE BURNER  
ALT-IRB



SIZZLER SEAR BURNER  
SIZ-IRB



AMG SEAR BURNER  
AMG-IRBNR

## ISLAND ACCESSORIES

Make your kitchen the way you want it... Summerset offers a variety of miscellaneous conveniences, upgrades, and appliances to customize your outdoor space to your liking. All products feature #304 stainless steel construction for durability and performance, matching handles and hardware, and various options.



UMBRELLA STANCHION LG/SM  
SSUS-1L / SSUS-1

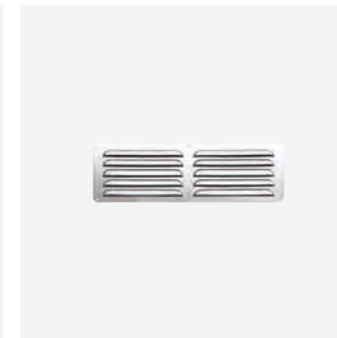

ISLAND VENT  
SSIV-1 / SSIV-M

## ROTISSERIE KITS AND BAGS

The Summerset rotisserie kit will really help you take your outdoor cooking to the next level. Complete with weather-protected stainless steel motor, fork set, counter balance and a spit rod for every grill, this kit has everything you need to start cooking your chicken, turkey, loin or roast like a pro. And when you're not searing up a masterpiece, keep your kit organized and protected with the rotisserie storage bag.



SUMMERSET ROTISSERIE KITS



AMG ROTISSERIE KITS

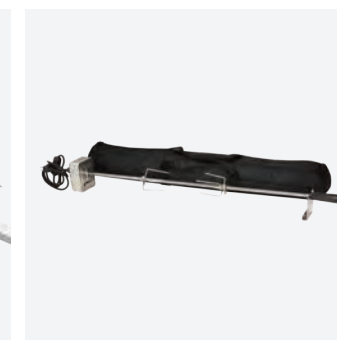

ROTISSERIE KIT STORAGE BAG  
RSB-SM(26-32) • RSB-LG(36-44)  
\*Rotisserie Kit Sold Separately

# CUTOUT DIMENSIONS

Measure twice, cut once. In this case we've done the measuring for you. Use the diagram below as a reference to customize your outdoor kitchen with efficiency and style.

Product	Model #	Cutout Dimensions ( W x H x D )	Diagram
<b>GRILLS</b>			
Builder Grill	SBG32	28½" x 10 <sup>3</sup> / <sub>16</sub> " x 23 <sup>1</sup> / <sub>16</sub> "	A
Sizzler 26" Grill	SIZ26	23¾" x 8½" x 20¾"	A
Sizzler/PRO 32" Grill	SIZ/PRO32	30¾" x 8½" x 20¾"	A
Sizzler/PRO 40" Grill	SIZ/PRO40	38" x 8½" x 20¾"	A
TRL 32" Grill	TRL32	30½" x 10" x 20¾"	A
TRL 38" Grill	TRL38	38½" x 10" x 20¾"	A
TRLD 44" Grill	TRLD44	45¼" x 11" x 20"	A
Alturi 30" Grill	ALT30	28½" x 10 <sup>3</sup> / <sub>16</sub> " x 23 <sup>1</sup> / <sub>16</sub> "	A
Alturi 36" Grill	ALT36	34½" x 10 <sup>3</sup> / <sub>16</sub> " x 23 <sup>1</sup> / <sub>16</sub> "	A
Alturi 42" Grill	ALT42	40½" x 10 <sup>3</sup> / <sub>16</sub> " x 23 <sup>1</sup> / <sub>16</sub> "	A
AMG 36" Grill	AMG-36	35" x 15" x 25"	A
<b>SIDE BURNERS</b>			
( W x H x D )			
Single Side Burner	SSSB-1	8" x N/A x 15½"	B
Sizzler/PRO Double Side Burner	SIZ/PROSB-2	10¾" x 8½" x 20¾"	B
TRL Double Side Burner	TRLSB-2	11¾" x 9" x 19"	B
Sear Side Burner	SSEAR-1	11¾" x 9" x 19"	B
Alturi Double Side Burner	ALT-2B	13¼" x 10¼" x 23"	B
Alturi Sear Side Burner	ALT-SS	13¼" x 10¼" x 23"	B
Power Burner	SSPB-1	13¾" x 9½" x 19"	B
AMG Power Burner	AMG-PB	14¼" x 12" x 19"	B
<b>UTILITY COMPONENTS</b>			
( W x H x D )			
Trash Chute	SSTC-1	6¼" x N/A x 8¼"	E
Beverage Center	SSBCL-1	28¼" x 10" x 23¾"	B
15" Sink & Faucet	SSNK-2	14¾" x N/A x 14¾"	B
Undermounted Sink	SSNK-3	13" x N/A x 11"	B
Ice Chest Large	SSIC-1	26¾" x 18¾" x 19½"	E
Ice Chest Small	SSIC-2	15½" x 11¾" x 23"	E
Island Vent	SSIV-1	12½" x 3 ¼" x N/A	-
Masonry Island Vent	SSIV-M	12" x 6" x N/A	-

Product	Model #	Cutout Dimensions ( W x H x D )	Diagram
<b>DOORS</b>			
( W x H x D )			
Vertical Mini Door	SSMD-1	14¼" x 16¼" x N/A	C
Vertical Door	SSDV-1	14¼" x 19¼" x N/A	C
Vertical Door Large	SSDVL-1, SSDVL-M	17¼" x 24¼" x N/A	C
Horizontal Door	SSHD-1	24¼" x 17¼" x N/A	C
Double Door 30"	SSDD-30, SSDD-30M	30¼" x 19½" x N/A	C
Double Door 36"	SSDD-36	34½" x 17¾" x N/A	C
Double Door 42"	SSDD-42, SSDD-42M	42¼" x 19½" x N/A	C
Door/2-Drawer Combo	SSDC-1, SSDC-M	30¼" x 19½" x 20¾"	C
Door/3-Drawer Combo	SSDC-3	29¾" x 20½" x 20½"	C
Pantry-Door Combo	SSPC-36	34½" x 17¾" x 20¾"	C
<b>DRAWERS</b>			
( W x H x D )			
Utility Drawer	SSUD-1	23¾" x 4" x 20¾"	C
Single Drawer	SSDR-1	15¼" x 10½" x 20¾"	D
Double Drawer	SSDR-2, SSDR-2M	15¼" x 19¼" x 20¾"	D
Triple Drawer	SSDR-3	15¼" x 27¾" x 20¾"	D
Double Horizontal Drawer	SSHDR-2	30½" x 6¼" x 20½"	D
Trash/LP Tank Drawer	SSTD-1, SSTD-M	18" x 24¾" x 20½"	D
Towel Drawer Holder	SSTDH-1	14¾" x 8¾" x 8¾"	D
Towel/2-Drawer Combo	SSTDC-1, SSTDC-M	15¼" x 27¾" x 20¾"	D
36" Storage Drawer	SSSD-36	34¾" x 17¾" x 22"	D
<b>REFRIGERATION</b>			
( W x H x D )			
Summerset / Alturi Refr.	SSRFR-1, ALTRFR-1	22" x 33½" x 24"	D
Outdoor Rated Refrigerator	ORFR-2	24" x 33¼" x 25"	D
Refrigerator Trim Kit	SSRTK-1	22¼" x 33½" x N/A	D
ORFR-2 Trim Kit	ORFR-2	24 <sup>3</sup> / <sub>16</sub> " x 33 <sup>3</sup> / <sub>16</sub> " x N/A	D

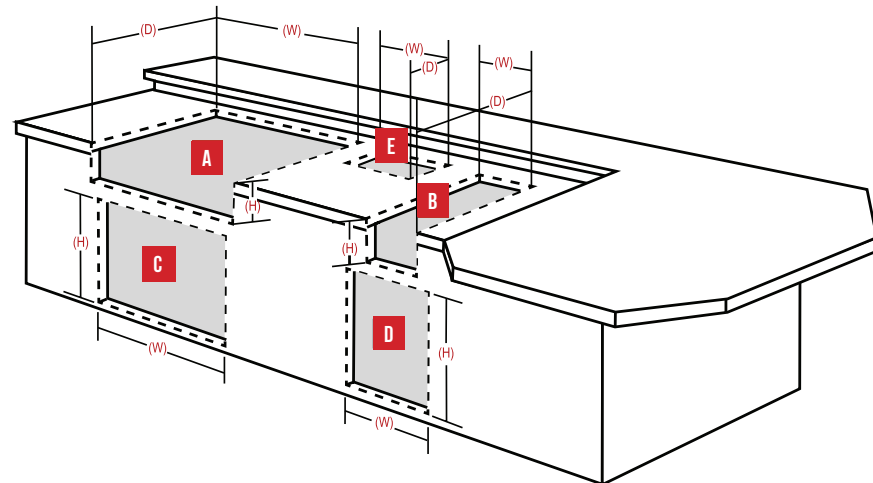

- A GRILLS**
- B SIDE BURNERS**
- C DOORS**
- D DRAWERS**
- E UTILITY COMPONENTS**

# WARRANTY

Summerset Professional Grills is now backed by our strongest warranty yet! In addition to precision engineering and outstanding performance, we've beefed up our Summerset grill series to include a LIFETIME WARRANTY. Now you can use a grill with the peace of mind that you have an industry leading warranty.

## SUMMERSET SERIES

- Lifetime warranty on construction and manufacturer defects
- Lifetime warranty on frame and housing
- Lifetime warranty on cooking grates, burners and valves
- 1 year warranty on all other parts, components, and electrical

## AMG SERIES

- Lifetime warranty on construction and manufacturer defects
- Lifetime warranty on frame and housing
- Lifetime warranty on cooking grates, burners and valves
- Lifetime warranty on burner cover and fuel trays
- 1 year warranty on all other parts, components, and electrical

## BUILDER GRILL

1 year warranty on workmanship, construction, and manufacturer defects for all commercial and/or hospitality applications. Warranty covers all factory defects. Warranty does not cover regular cleaning, vandalism, misuse, or theft. All warranty claims are subject to manufacturer review. Warranty is valid only provided that regular maintenance is exercised. Due to the nature of commercial applications (multiple users, lack of control of use, etc.) regular maintenance is mandatory.

## COMPONENTS

- Limited lifetime warranty on construction, workmanship and materials for all stainless steel components, including doors, drawers, ice chests, beverage centers, sinks and grill liners.
- Limited (5 year) warranty on carts.
- Limited (1 year) warranty on grill covers.

Summerset Professional Grills Warranty is valid for original purchaser at original site of delivery with proof of purchase and photo documentation only. Registration form must be submitted within 30 days of the purchase date to validate the warranty. Warranty is void upon transfer of ownership. Warranty does not apply to products installed in any commercial, rental, or non-residential application. Warranty covers replacement parts only. Manufacturer is not responsible for labor or labor-related costs. Warranty does not cover discoloration, surface rust, corrosion, or oxidation, which may occur due to harsh environments, chemicals, or overheating. Warranty will not apply for damage resulting from improper installations, abuse, extreme environments, grease fires, or misuse. Regular and proper maintenance is required. Coastal, humid, and/or salt environments are subject to manufacturer review. All out-of-box claims must be made within 30 days of purchase and must be made prior to installation. Any product installed damaged will be considered damaged during installation and not covered under warranty. Warranty and registration forms are available at [www.SummersetGrills.com](http://www.SummersetGrills.com). Please be advised - all display models are sold "as is" and the warranty covers the following items only: main burners (lifetime), grates (lifetime), burner covers (1 year). All warranties are subject to the review and approval of the manufacturer.



To get more warranty details and maintenance tips visit [www.summersetgrills.com](http://www.summersetgrills.com)



# SUMMERSET PROFESSIONAL GRILLS

17322 GOTHARD STREET, HUNTINGTON BEACH CA, 92647 | (800) 966-8126 | [SUMMERSETGRILLS.COM](http://SUMMERSETGRILLS.COM)