

USA / CANADA EDITION



Design Wood Fireplaces



The individual fireplace with a built-in fireplace insert

SPARTHERM supplies modern, durable fireplace inserts featuring winning technology and design. We commit all our know-how and technical skill when making our inserts because – after all – they are the heart of the fireplace. As well as the exterior, our fireplace inserts are also impressive in terms of what's inside!



SPARTHERM – The Fire Company



We produce in two locations. Spartherm Feuerungstechnik GmbH is one of the largest manufacturers of fireplace inserts, heating cassettes and stoves in Europe.



Technology. Precision. Future.

The name SPARTHERM stands for innovative stove solutions which not only meet top demands in their design but are also high quality and long lasting. This quality philosophy runs through the entire process: from the idea to development and the meticulous production processes through delivery and service – all from one single source.

Spartherm is one of Europe's biggest producers of fireplace inserts, stoves and cassettes. Our employees' know-how is the accumulated experience of more than 30 years and they are committed to being the best in their daily work – each in his or her own particular area, but all with the same goal: perfect products and enthusiastic customers.

In two factories – on a total of around 35,000 m² of production space – we plan, develop and manufacture more than 60,000 units per year: with state-of-the-art facilities, in efficient production processes, in top quality.

With a huge effort and lots of care, we also plan, develop and manufacture personal gems: in our production, we fulfil the very special dreams of our customers – custom-made designs to meet every requirement.

The basis of our success? The high technical quality of the stoves combined with stylish design and consistent innovations in the sector of combustion technology. That is the status quo and it will stay that way. A promise you can rely on.





Our production lines in Melle, Germany and Strzelce Kraje'nskie, Poland: ultra-modern facilities, efficient manufacturing processes and top quality.



And what are your demands?

Mr. Dr. Volker Schmatloch
Doctor of physics
talks about environment
and sustainability



The word 'innovation' comes from the Latin innovare, to renew. We don't interpret this as a renaissance of tradition, but as continuous development looking ahead to a changing future. An approach we especially feel obliged to with regard to what's really important for us and for the future of our children: our environment. We at SPARTHERM take good care and responsibility to ensure that our products do not only meet, but overcome all requirements for an ef-

ficient combustion with minimal emissions. Therefore we do not only put lots of effort in research and further development of the unique looks of our fireplaces, but also focus on what's inside.

Contemporary design and customer relations are our hallmarks, we therefore received the 2016 German brand award among lots of other design prizes in Germany.

But when it comes to sustainability and protecting the environment we live in, we are striving for perfection to give you a perfect combination of both worlds: outstanding design paired with environmental awareness.

Be inspired.



Frank Rokossa

Frank Rokossa
CEO

G. M. Rokossa.

Gerhard Manfred Rokossa
Founder and owner

Contents

Page 08 - 11	Straight	<input type="checkbox"/>
Page 12 - 13	Double sided (see-thru)	<input type="checkbox"/>
Page 14 - 15	L-Shape	<input type="checkbox"/>
Page 16 - 23	U-Shape	<input type="checkbox"/>
Page 24 - 25	Door function	
Page 26 - 35	Technical details	

Quality and variety

Whether as an inspired vision of the fireplace inserts of the future or in terms of the reliability and meticulous manufacturing of the products, SPARTHERM's high quality standards are unrivalled. Contemporary design, modernity and technological perfection are the hallmarks of all SPARTHERM fireplace inserts.



Made in Germany

Varia M-80h-4S

26



Varia Bh-4S

27



Clear shapes – absolutely linear





Arte Bh-4S

27

Freedom all
along the line



Front view ...and back view



Varia B-FDh-4S

30 €

Great view of the fire from both sides

Double sided fireplaces of a special kind:
„Two“ fireplaces in one room.
More freedom, more benefits,
more living comfort.



Varia B-FDh-4S

30 

"Perfection is achieved, not when there is nothing more to add, but when there is nothing left to take away."

Antoine de Saint-Exupéry

Varia 2L-80h

€ 28



Varia 2R-100h-4S

€ 29





Appealing to the emotions from any angle



Arte 3RL-60h-4S

30 €

Arte 3RL-80h-4S

€ 31





Arte 3RL-60h-4S

30 

Arte 3RL-100h-4S

31





Playing with size and strength

Only by crossing boundaries can we gain more space, and only by overcoming the ordinary can we enjoy the extraordinary.



Arte U-50h-4S



Arte U-70h-4S

32 €

True elegance
combined with
top performance



Arte U-70h-4S

32 €



Technical Informations



Convenient handle for glass cleaning.
For quick opening without tools –
in just a blink of an eye



Open glass with
our operational tool



... the glass is easy to clean



The 4S version with 4-sided
printed glass ceramics



SCHOTT ROBAX is our main supplier,
guaranteeing for top notch quality glass matching
the SPARTHERM standard



Foldable grid for easy removal
of the ash pan

DOOR OPENING

Flat and angled door



Use the "operational tool" to open and close the door



Minimalistic lever



Position the "operational tool" on the lever at the bottom handle side of the door

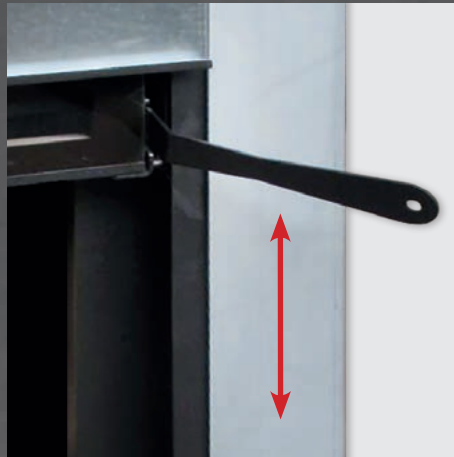

You can now easily move the door up and down

Double angled door



Straight version of our operational tool



Holding lever



A sleek and minimalistic design made by SPARTHERM



Our perfectly adjusted counter weights guarantee a smooth and comfortable door sliding

Varia M-80h

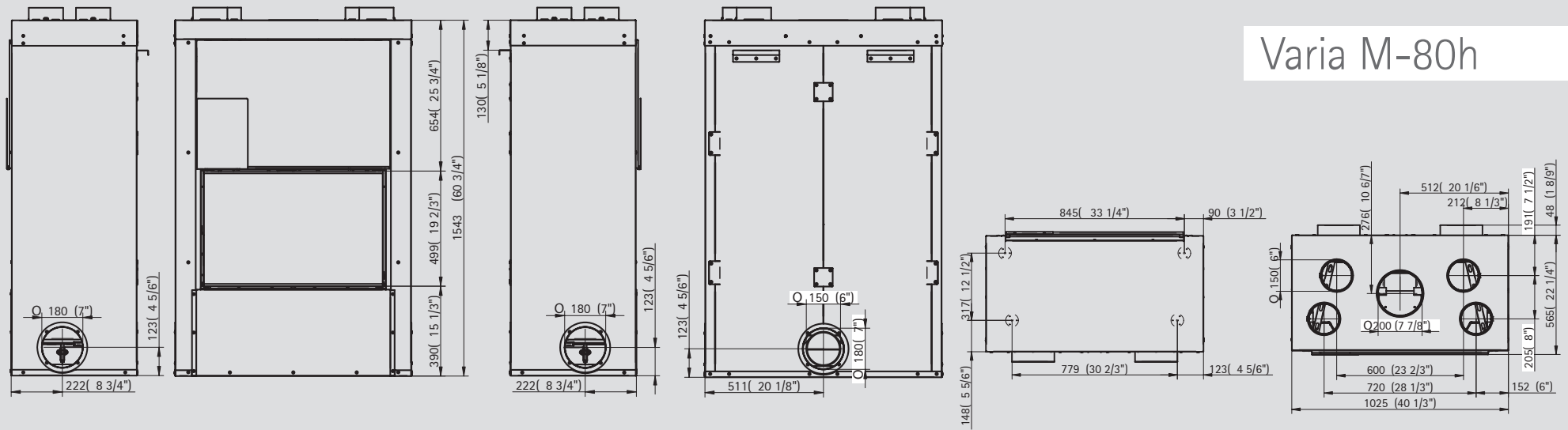

Varia M-100h

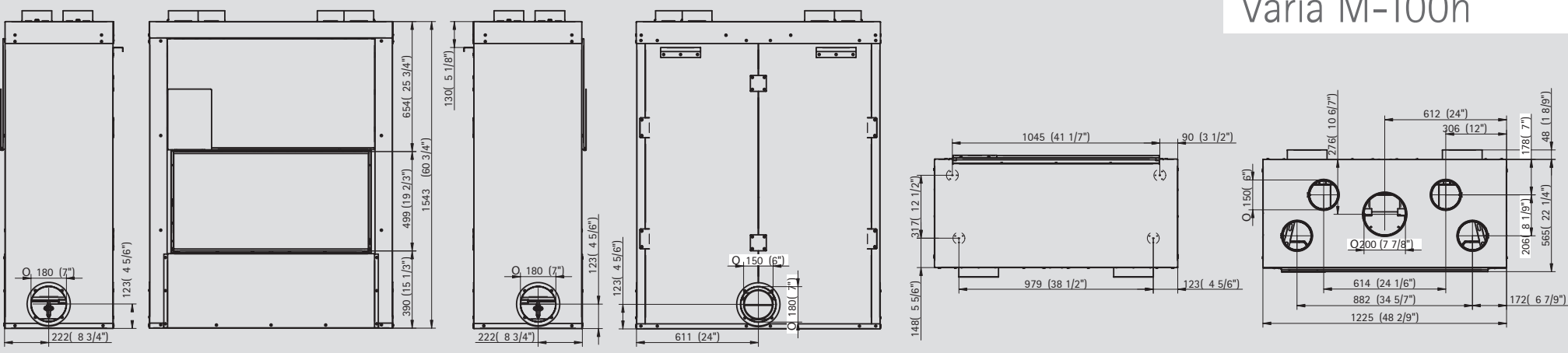

Varia Bh

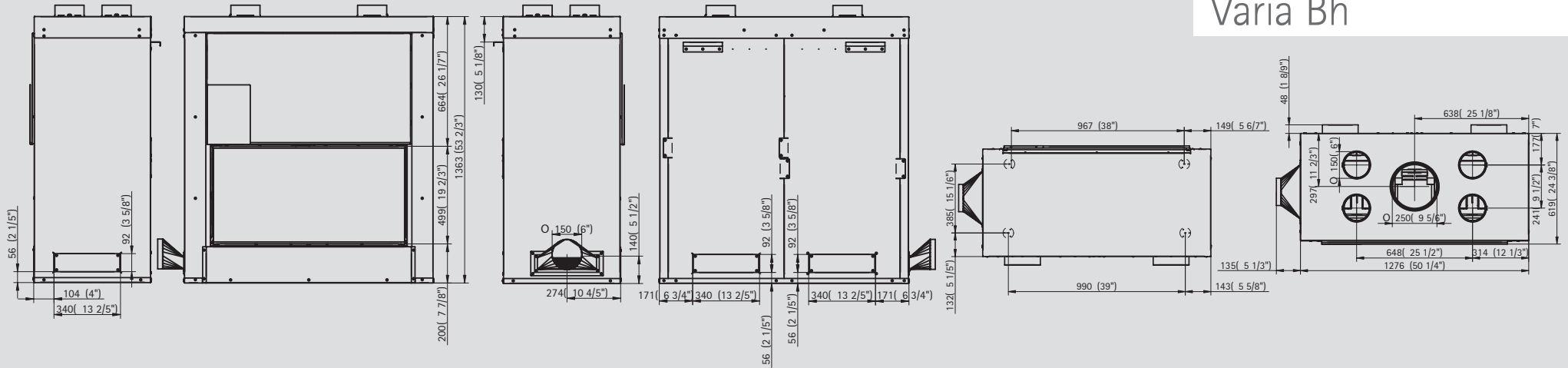

Arte Bh

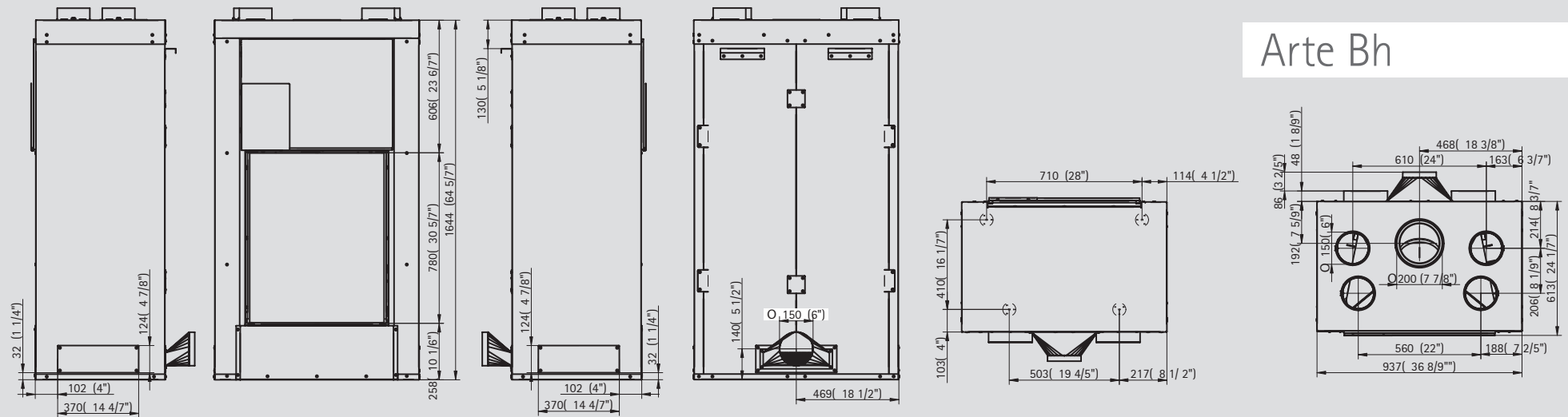

All representations and drawings are protected by applicable copyright laws. Utilization or publication, including individual details, only with our written approval. Technical data subject to change. Errors and omissions excepted.

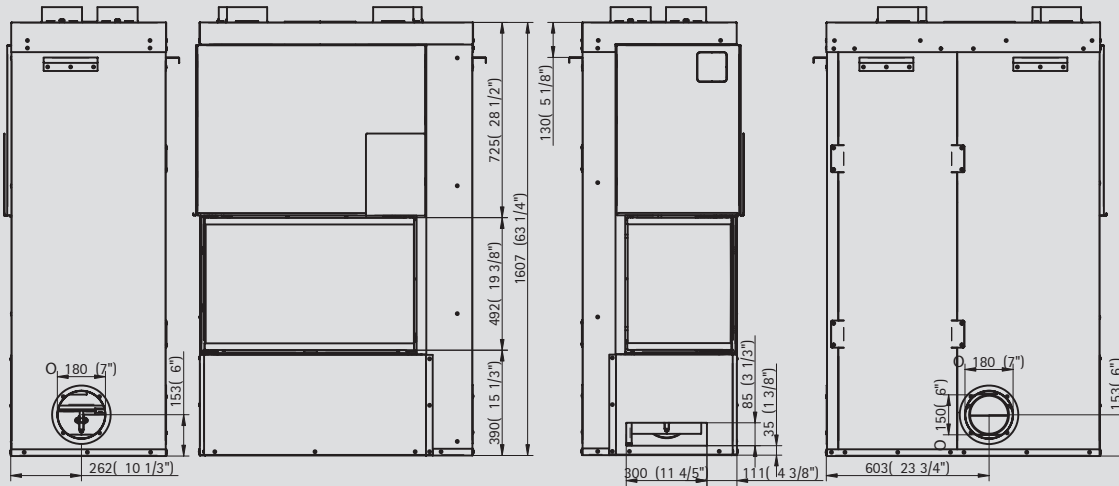

Varia 2L-80h

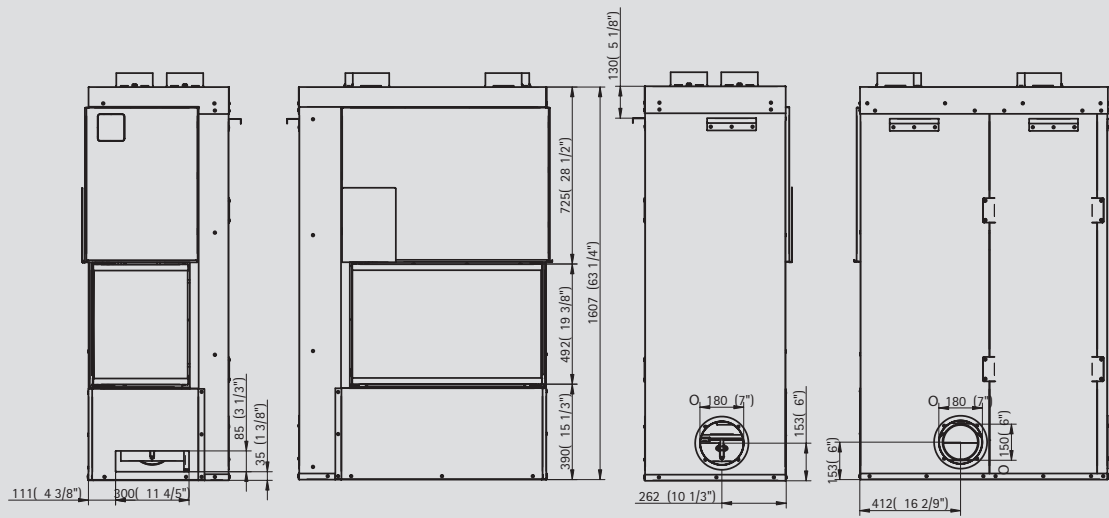
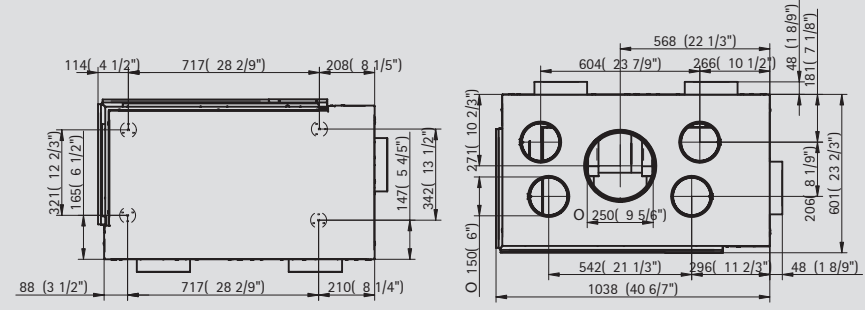

Varia 2R-80h

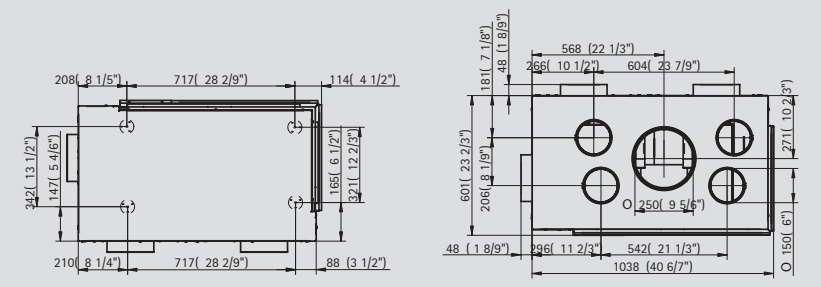

Varia 2L-100h

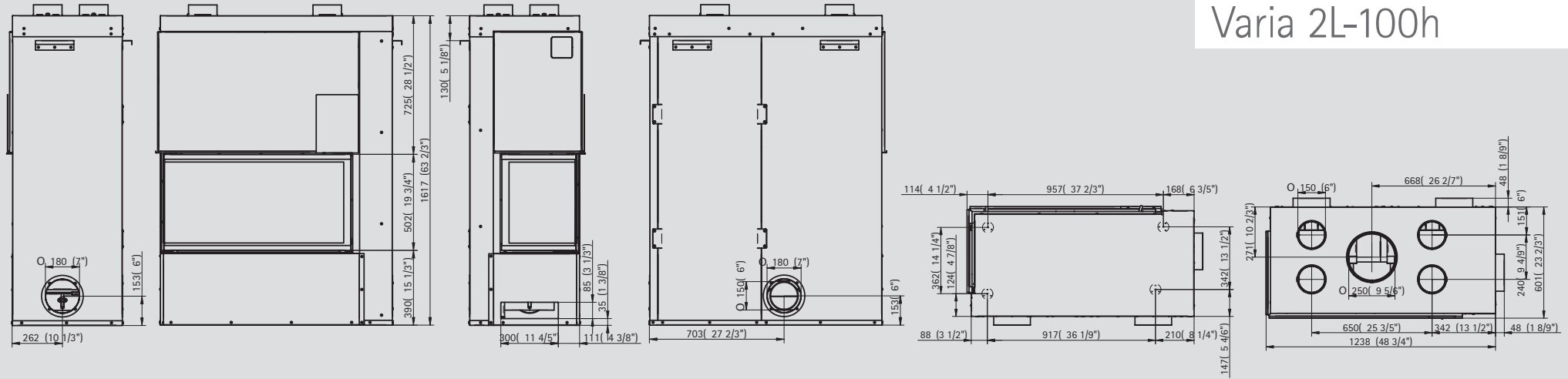

Varia 2R-100h

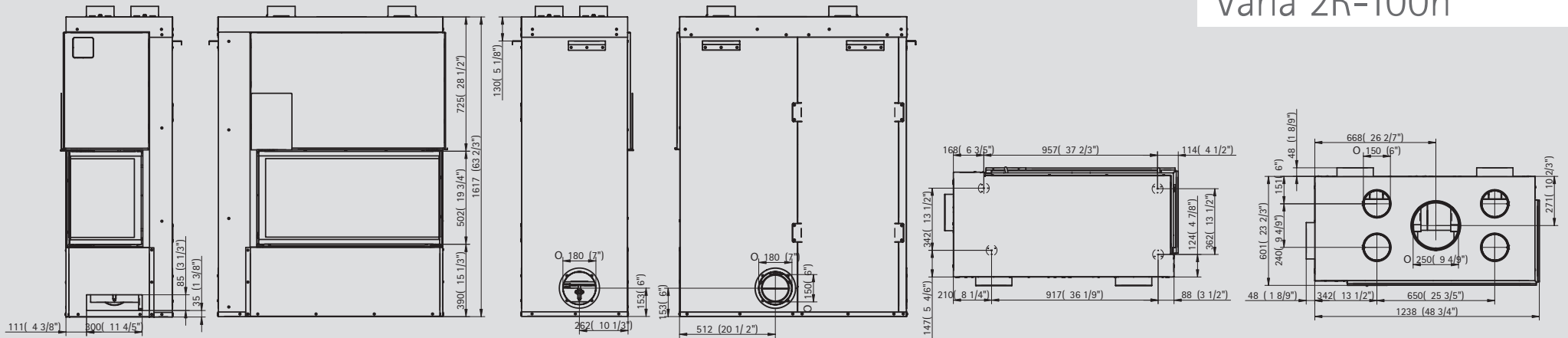

All representations and drawings are protected by applicable copyright laws. Utilization or publication, including individual details, only with our written approval. Technical data subject to change. Errors and omissions excepted.

Varia B-FDh

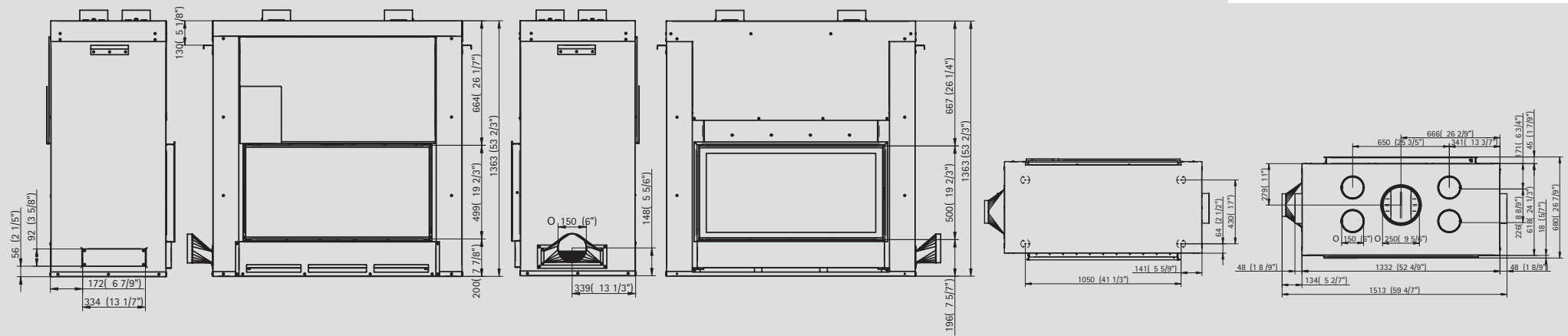

Arte 3RL-60h

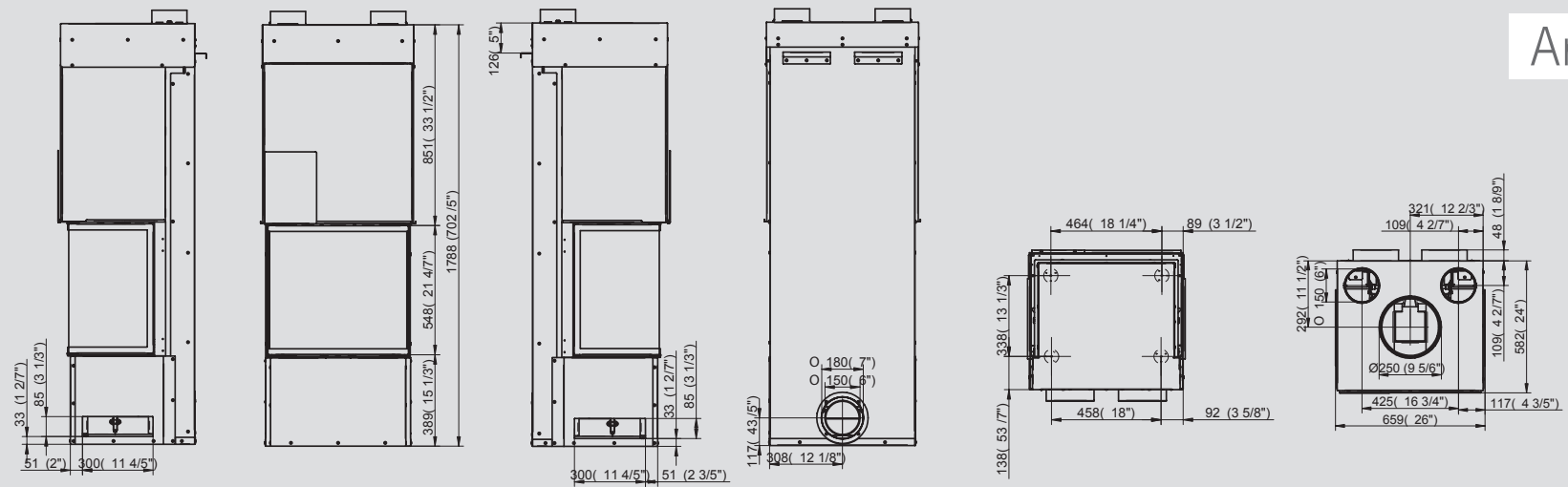

Arte 3RL-80h

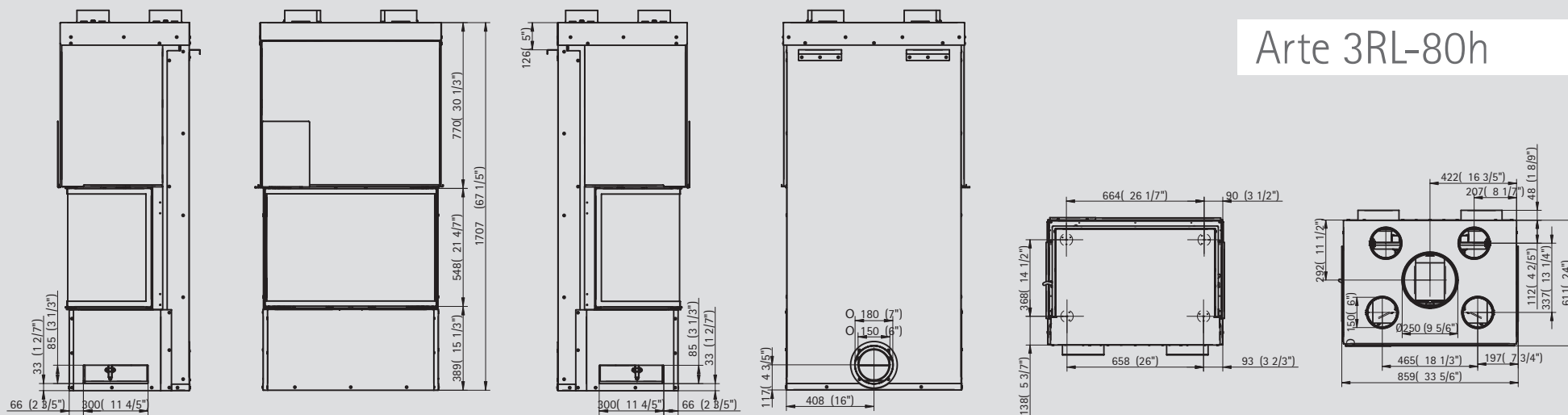

Arte 3RL-100h

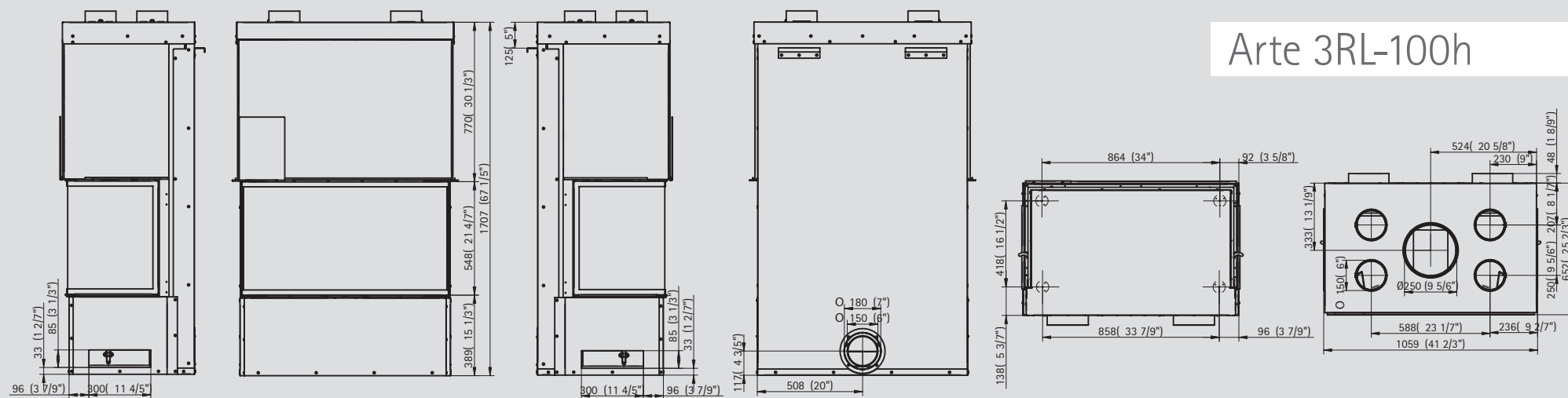

All representations and drawings are protected by applicable copyright laws. Utilization or publication, including individual details, only with our written approval. Technical data subject to change. Errors and omissions excepted.

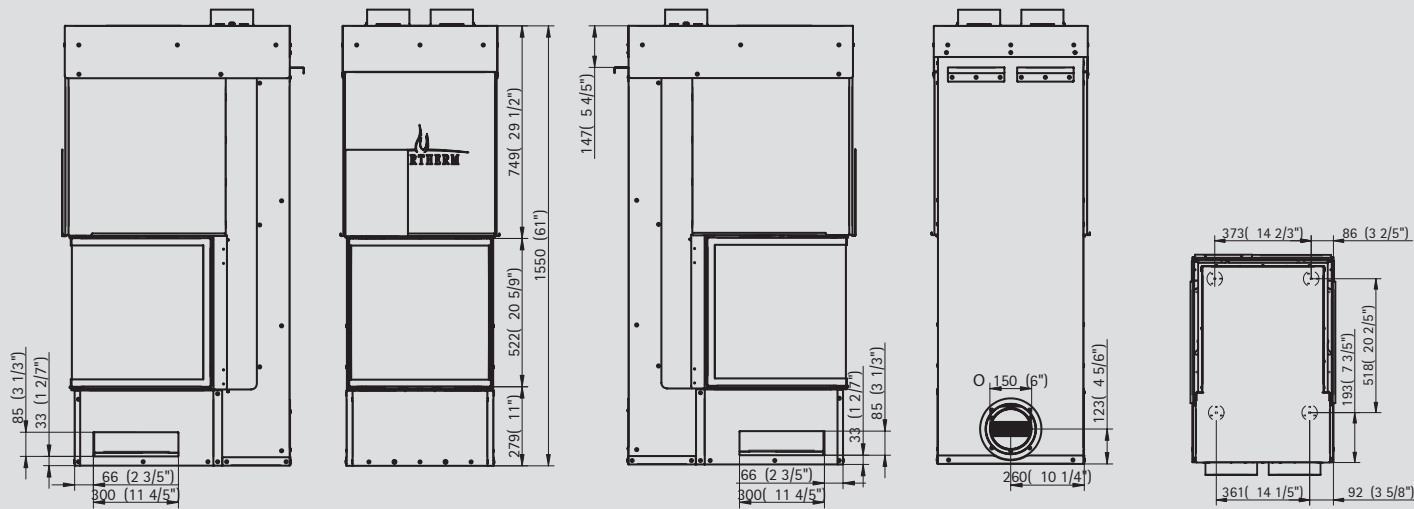

Arte U-50h

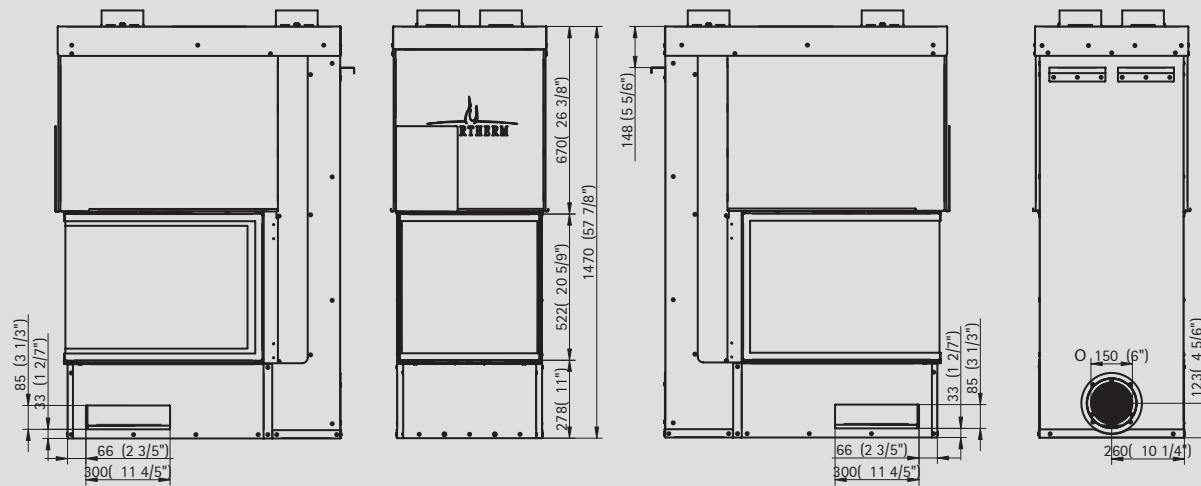
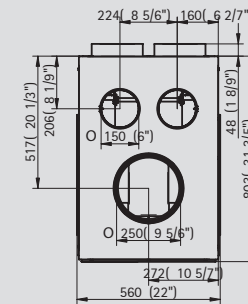

Arte U-70h

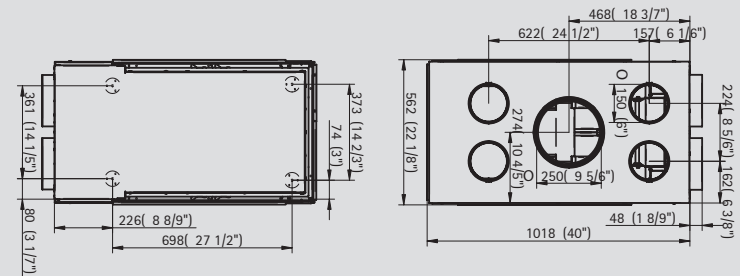

Specifications

	Hearth Volume cu.ft.	Minimum Power	Maximum power	Efficiency*	Chimney Diameter in.	Unit weight	Recommended log size	Door Dimensions WxHxD in inch (mm)
Varia M-80h	3.50 ft ³	21500 BTU	40000 BTU	≥78%	8"	662 lbs	20" (330mm)	31-9/16" x 19-11/16" (802 x 500mm)
Varia M-100h	4.11 ft ³	26000 BTU	49000 BTU	≥78%	8"	772 lbs	20" (508mm)	38-9/16" x 19-11/16" (980 x 500mm)
Varia Bh	4.28 ft ³	25000 BTU	46000 BTU	≥78%	10"	772 lbs	20" (508mm)	39-9/16" x 19-11/16" (1006 x 500mm)
Arte Bh	4.20 ft ³	26000 BTU	49000 BTU	≥78%	8"	573 lbs	18" (457mm)	29-9/16" x 30-11/16" (656 x 780mm)
Varia 2L/2R-80h	4.14 ft ³	25000 BTU	46000 BTU	≥80%	10"	606 lbs	18" (457mm)	30-1/2" x 19-3/8" x 15-1/8" (775 x 492 x 385mm)
Varia 2L/2R-100h	4.16 ft ³	26500 BTU	49000 BTU	≥78%	10"	617 lbs	20" (508mm)	30-1/2" x 19-3/8" x 15-1/8" (975 x 502 x 385mm)
Varia B-FDh	6.83 ft ³	26500 BTU	49000 BTU	≥78%	10"	772 lbs	18" (457mm)	Front 39-9/16" x 19-11/16" " (1006 x 500mm) Back 39-3/4" x 19-11/16" " (1010 x 500mm)
Arte 3RL-60h	2.71 ft ³	19000 BTU	33500 BTU	≥80%	10"	551 lbs	18" (457mm)	23-5/8" x 21-11/16" x 14-1/2" (600 x 550 x 370mm)
Arte 3RL-80h	4.38 ft ³	21500 BTU	40000 BTU	≥80%	10"	617 lbs	18" (457mm)	31-1/2" x 21-11/16" x 15-3/4" (800 x 550 x 400mm)
Arte 3RL-100h	5.88 ft ³	26000 BTU	49000 BTU	≥78%	10"	662 lbs	18" (457mm)	39-3/8" x 21-11/16" x 17-11/16" (1000 x 550 x 450mm)
Arte U-50h	2.67 ft ³	21500 BTU	40000 BTU	≥80%	10"	529 lbs	18" (457mm)	19-11/16" x 20-11/16" x 16-11/16" (501 x 525 x 499mm)
Arte U-70h	3.94 ft ³	26000 BTU	49000 BTU	≥78%	10"	827 lbs	18" (457mm)	19-11/16" x 20-11/16" x 28" (501 x 525 x 713mm)
Arte U-90h	6.10 ft ³	31000 BTU	57500 BTU	≥78%	10"	1023 lbs	18" (457mm)	21-11/16" x 20-11/16" x 36" (501 x 525 x 913mm)



*efficiency results: as per formal European testing EN13229

Conversion Factors

Inches to millimeters (mm): 1" = 25.4mm
British Thermal Unit BTU/h to Watt: 1BTU/h = 0.293 Watt

Kilogram to Pound: 1kg = 2.205 lb
Cubic-meter to cubic-feet: 1m³ = 35.314 ft³

Wood consumed per hour

Appliance	Wood consumed per hour	Appliance	Wood consumed per hour	Appliance	Wood consumed per hour
Varia M-80h	4.2 - 7.9 lbs	Varia 2L/2R-80h	4.9 - 9.0 lbs	Arte U-50h	4.2 - 7.7 lbs
Varia M-100h	5.3 - 9.7 lbs	Varia 2L/2R-100h	5.1 - 9.7 lbs	Arte U-70h	5.3 - 9.7 lbs
Varia Bh	4.9 - 9.3 lbs	Arte 3RL-60h	3.3 - 6.2 lbs	Arte U-90h	6.2 - 11.5 lbs
Arte Bh	5.3 - 9.7 lbs	Arte 3RL-80h	4.2 - 7.7 lbs		
Varia B-FDh	5.3 - 9.7 lbs	Arte 3RL-100h	5.3 - 9.7 lb		

Be inspired.



SPARTHERM - The Fire Company

SPARTHERM has been producing for years according to the highest quality standards and can therefore provide the quality seal as a guarantee for best materials and perfect workmanship.

**SCHOTT
ROBAX®**

Despite using only the best components for our solid steel bodies and movable parts, we make sure that we work closely together with only the best glass producers in the industry. SCHOTT ROBAX is therefore our main supplier, guaranteeing for top notch quality glass ceramics matching the SPARTHERM standard.

All our appliances have been tested EPA decorative according to American and Canadian standards.



Your specialist dealer:

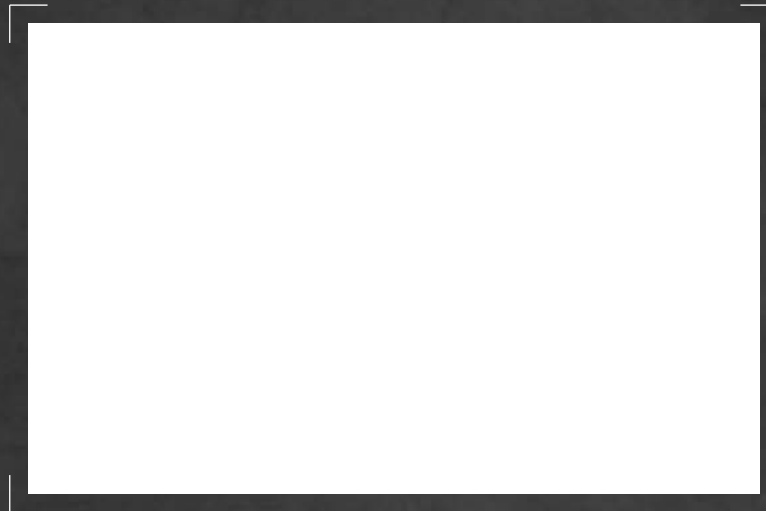

SPARTHHERM Feuerungstechnik GmbH

Maschweg 38 · 49324 Melle · Germany

Tel. +49 5422/94 41-0 · Fax +49 5422/94 41-14

info@spartherm.com · www.spartherm.com

powrmatic

MONTRÉAL • QUÉBEC • OTTAWA • HALIFAX • TORONTO • LONDON

